

Operating Instructions

Network Camera

Model No. **BL-VT164 Series**
BL-VP100 Series

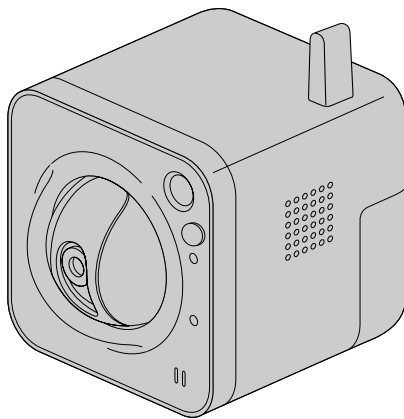

BL-VT164W

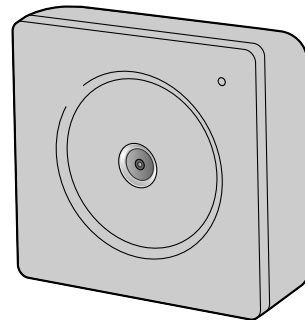

BL-VP104W

This manual covers the models: BL-VT164 Series (BL-VT164W, BL-VT164, BL-VT164WE, BL-VT164E, BL-VT164WU, BL-VT164U) and BL-VP100 Series (BL-VP104W, BL-VP104, BL-VP101, BL-VP104WE, BL-VP104E, BL-VP101E, BL-VP104WU, BL-VP104U, BL-VP101U).

Before attempting to connect or operate this product, please read these instructions carefully and save this manual for future use.

The model number is abbreviated in some descriptions in this manual.

Preface

About the user manuals

There are 2 sets of operating instructions for the BL-VT164W, BL-VT164, BL-VP104W, BL-VP104, BL-VP101 (P model), BL-VT164WE, BL-VT164E, BL-VP104WE, BL-VP104E, BL-VP101E (E model), BL-VT164WU, BL-VT164U, BL-VP104WU, BL-VP104U, BL-VP101U (U model) as follows.

- **Installation Guide:** Explains how to install and connect devices.
When you use the BL-VT164W/BL-VT164WE/BL-VT164WU or BL-VT164/BL-VT164E/BL-VT164U, refer to BL-VT164W/BL-VT164WE/BL-VT164WU/BL-VT164/BL-VT164E/BL-VT164U Installation Guide.
When you use the BL-VP104W/BL-VP104WE/BL-VP104WU, BL-VP104/BL-VP104E/BL-VP104U, or BL-VP101/BL-VP101E/BL-VP101U, refer to BL-VP100 Series Installation Guide.
- **Operating Instructions:** Explains how to perform the settings and how to operate this camera. This Operating Instructions covers the models: BL-VT164W, BL-VT164, BL-VP104W, BL-VP104, BL-VP101, BL-VT164WE, BL-VT164E, BL-VP104WE, BL-VP104E, BL-VP101E, BL-VT164WU, BL-VT164U, BL-VP104WU, BL-VP104U, BL-VP101U.

The model number is abbreviated in some descriptions in this manual.

The screens used in these operating instructions show the case of BL-VT164 (P model). Depending on the model used, the screens shown in the explanations may differ to the actual camera screens.

About notations

The following notations are used when describing the functions limited for specified models. The functions without the notations are supported by all models.

- **VT164W**: The functions with this notation are available when using the model BL-VT164W.
- **VT164**: The functions with this notation are available when using the model BL-VT164.
- **VP104W**: The functions with this notation are available when using the model BL-VP104W.
- **VP104**: The functions with this notation are available when using the model BL-VP104.
- **VP101**: The functions with this notation are available when using the model BL-VP101.

Trademarks and registered trademarks

- Microsoft, Windows, Windows Vista, Internet Explorer, ActiveX and DirectX are either registered trademarks or trademarks of Microsoft Corporation in the United States and/or other countries.
- Microsoft product screen shot(s) reprinted with permission from Microsoft Corporation.
- iPad, iPhone, and iPod touch are trademarks of Apple Inc., registered in the U.S. and other countries.
- Android is a trademark of Google Inc. Use of this trademark is subject to Google Permissions.
- All other trademarks identified herein are the property of their respective owners.

Abbreviations

The following abbreviations are used in these operating instructions.

Microsoft® Windows® 7 is described as Windows 7.

Microsoft® Windows Vista® is described as Windows Vista.

Microsoft® Windows® XP SP3 is described as Windows XP.

Windows® Internet Explorer® 9.0, Windows® Internet Explorer® 8.0, Windows® Internet Explorer® 7.0 and Microsoft® Internet Explorer® 6.0 are described as Internet Explorer.

Universal Plug and Play is described as UPnP™ or UPnP.

Viewer software

It is necessary to install the viewer software “Network Camera View 4S” to display images on a PC. This software can be installed directly from the camera or by selecting the [Install] button next to [Viewer Software] on the menu of the CD-ROM provided, and then following the on-screen instructions.

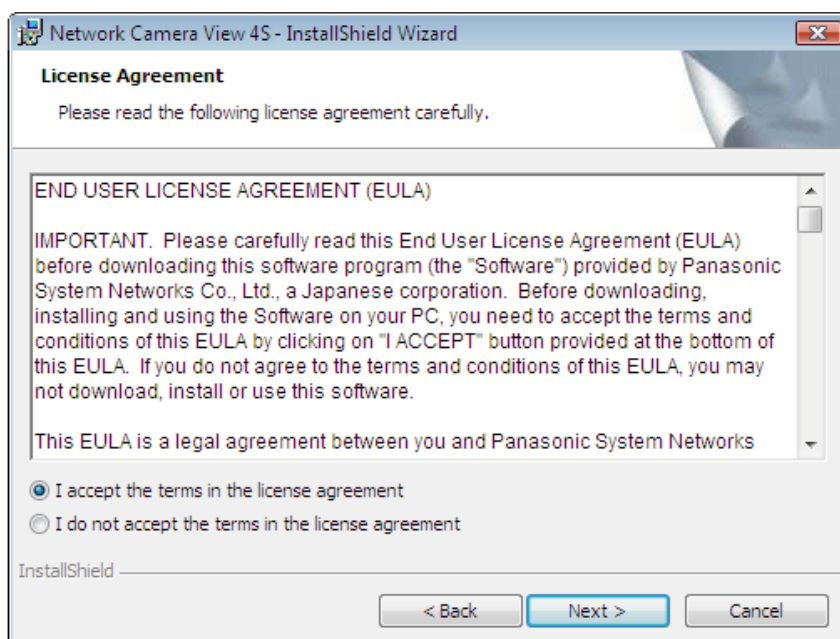

IMPORTANT

- The default setting of “Automatic installation of viewer software” is “On”. Follow the instructions on page 178 when the message is displayed on the information bar of the browser.
- When the “Live” page is displayed for the first time, the install wizard of the ActiveX® control required to display images from the camera will be displayed. Follow the instructions of the wizard.
- When the install wizard is displayed again even after completing the installation of the ActiveX, restart the PC.
- The viewer software used on each PC should be licensed individually. The number of installations of the viewer software from the camera can be checked on the [Upgrade] tab of the “Maintenance” page (→page 154). Refer to your dealer for the software licensing.

Table of Contents

- 1 Monitor images on a PC7**
- 1.1 Monitor images from a single camera7
- 1.2 About the “Live” page (BL-VT164W/BL-VT164)10
- 1.3 About the “Live” page (BL-VP104W/BL-VP104/BL-VP101)15
- 1.4 Monitor images from multiple cameras18
- 2 Monitor images on a cellular phone/mobile terminal19**
- 2.1 Monitor images on a cellular phone19
- 2.2 Monitor images on a mobile terminal22
- 3 Action at an alarm occurrence30**
- 3.1 Alarm type30
- 3.2 Action at an alarm occurrence30
- 4 Transmit images onto an FTP server32**
- 4.1 Transmit an alarm image at an alarm occurrence (Alarm image transmission)32
- 4.2 Transmit images at a designated interval or period (FTP periodic image transmission)32
- 5 About the network security33**
- 5.1 Equipped security functions33
- 6 Display the setup menu from a PC34**
- 6.1 How to display the setup menu34
- 6.2 How to operate the setup menu35
- 6.3 About the setup menu window37
- 7 Configure the basic settings of the camera [Basic]39**
- 8 Configure the Internet settings [Internet]44**
- 9 Configure the settings relating to images and audio [Image/Audio] (BL-VT164W/BL-VT164)/ Configure the settings relating to images [Image] (BL-VP104W/BL-VP104/BL-VP101)46**
- 9.1 Configure the settings relating to the aspect ratio [JPEG/H.264]46
- 9.2 Configure the settings relating to JPEG images [JPEG/H.264]47
- 9.3 Configure the settings relating to H.264 images [JPEG/H.264]49
- 9.4 Configure the settings relating to the camera operations [Cam. Function] (BL-VT164W/BL-VT164)55
- 9.5 Configure the settings relating to images and the preset positions [Image/Position] (BL-VT164W/BL-VT164)/ Configure the settings relating to image adjust, extra zoom, and privacy zone [Image/Privacy] (BL-VP104W/BL-VP104/BL-VP101)57
- 9.5.1 Configure the settings relating to image quality (“Image adjust” setup menu)58
- 9.5.2 Set mask areas62
- 9.5.3 Configure the settings relating to the preset positions (“Preset position” setup menu) (BL-VT164W/BL-VT164)65
- 9.5.3.1 Register the preset positions66
- 9.5.4 Adjust the angular field of view using the extra zoom function (BL-VP104W/BL-VP104)68
- 9.5.5 Configure the settings relating to the privacy zone (“Privacy zone” setup menu) (BL-VT164W/BL-VT164)68

9.5.6	Configure the settings relating to the privacy zone (“Privacy zone” setup menu) (BL-VP104W/BL-VP104/BL-VP101)	70
9.6	Configure the settings relating to audio [Audio] (BL-VT164W/BL-VT164)	72
10	Configure the multi-screen settings [Multi-screen]	75
11	Configure the alarm settings [Alarm]	77
11.1	Configure the settings relating to the alarm action [Alarm]	77
11.2	Configure the settings relating to the camera action on alarm occurrence [Alarm] (BL-VT164W/BL-VT164)	79
11.3	Configure the settings relating to the alarm image [Alarm]	80
11.4	Configure the settings relating to the alarm output terminal [Alarm] (BL-VT164W/BL-VT164)	82
11.5	Change the AUX name [Alarm] (BL-VT164W/BL-VT164)	83
11.6	Configure the VMD settings [VMD area]	84
11.7	Configuration of the settings relating to the E-mail notification [Notification]	87
11.8	Configure the settings relating to Panasonic alarm protocol [Notification]	88
12	Configure the setting relating to the image recognition [Advanced func.]	91
12.1	Configure the settings relating to the XML notification [XML notification]	91
12.2	Configuration of the settings relating to the face detection [Face detection]	93
13	Configure the settings relating to the authentication [User mng.]	94
13.1	Configure the settings relating to the user authentication [User auth.]	94
13.2	Configure the settings relating to the host authentication [Host auth.]	95
13.3	Configure the settings relating to the priority stream [System]	96
14	Configure the settings of the servers [Server]	99
14.1	Configure the settings relating to the E-mail server [E-mail]	99
14.2	Configure the settings relating to the FTP server [FTP]	100
14.3	Configure the settings relating to the NTP server [NTP]	101
15	Configuring the network settings [Network]	104
15.1	Configure the network settings [Network]	104
15.2	Configure the HTTPS settings	112
15.2.1	Generation of the CRT key (SSL encryption key)	113
15.2.2	Generation of the self-signed certificate (security certificate)	114
15.2.3	Generation of CSR (Certificate Signing Request)	116
15.2.4	Installation of the server certificate	117
15.2.5	Configuration of the connection protocol	118
15.3	Access the camera using the HTTPS protocol	119
15.3.1	Install the security certificate	119
15.4	Configure the settings relating to DDNS [DDNS]	129
15.4.1	Configuration of the DDNS service (Example of the “Viewnetcam.com” service)	130
15.4.2	When using the “Viewnetcam.com” service	131
15.4.3	Procedure to register information for the “Viewnetcam.com” service	132
15.4.4	Checking the information registered for the “Viewnetcam.com” service	133
15.4.5	When using “Dynamic DNS Update”	133
15.4.6	When using “Dynamic DNS Update(DHCP)”	134
15.5	Configure the settings relating to SNMP [SNMP]	134
15.6	Configure the settings relating to the FTP periodic image transmission [FTP img. trans.]	135

15.7	Configure the schedule settings of the FTP periodic image transmission [FTP img. trans.]	137
15.7.1	How to set the schedules	137
15.7.2	How to delete the set schedule	138
16	Use the camera on a wireless LAN [Wireless] (BL-VT164W/BL-VP104W)	140
16.1	Manually connecting the camera to a wireless LAN (manual settings) [Basic]	140
16.2	Connecting the camera to a wireless LAN with WPS (automatic settings) [Basic]	144
16.3	Using the camera's Wireless QoS [Basic]	148
16.4	Confirming the camera's wireless information [Status]	148
17	Configure the settings relating to the schedules [Schedule]	151
18	Maintenance of the camera [Maintenance]	154
18.1	Check the system log [System log]	154
18.2	Upgrade the firmware [Upgrade]	154
18.3	Check the status [Status]	156
18.4	Reset the settings/Reboot the camera [Default reset]	157
19	Privacy Mode (BL-VT164W/BL-VT164)	159
19.1	Configuring the Privacy Mode with the PRIVACY button	159
19.2	Configuring the Privacy Mode with the setup menu	160
19.3	Turning the Privacy Mode off	160
20	Using the CD-ROM	161
20.1	About the CD launcher	161
20.2	Installing Panasonic "IP Setting Software"	162
20.3	Installing the manuals	163
20.4	Installing the Viewer software	163
20.5	Configure the network settings of the camera using the Panasonic "IP Setting Software"	164
21	About the displayed system log	166
22	Troubleshooting	170

1 Monitor images on a PC

The following are descriptions of how to monitor images from the camera on a PC.

1.1 Monitor images from a single camera

1. Start up the web browser.
2. Enter the IP address designated using the Panasonic “IP Setting Software” in the address box of the browser.
 - **Example when entering an IPv4 address:** http://URL registered using IPv4 address
http://192.168.0.10/
 - **Example when entering an IPv6 address:** http://[URL registered using IPv6 address]
http://[2001:db8::10]/

<Example of IPv4 access>

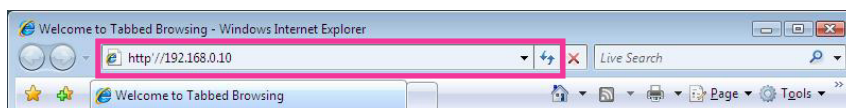

<Example of IPv6 access>



IMPORTANT

- When the HTTP port number is changed from “80”, enter “http://IP address of the camera + : (colon) + port number” in the address box of the browser. (Example: http://192.168.0.11:8080)
- When the PC is in a local network, configure the proxy server setting of the web browser (under [Internet Options...] under [Tools] of the menu bar) to bypass the proxy server for the local address.

Note

- Refer to page 119 for further information about the case in which “HTTPS” is selected for “HTTPS” - “Connection” on the [Network] tab of the “Network” page (→page 104).

1 Monitor images on a PC

3. Press the [Enter] key on the keyboard.
→ The window with the user name and password entry fields will be displayed.



Connect to 192.168.0.10

Panasonic network device

User name:

Password:

Remember my password

OK Cancel

4. Enter the user name and the password.
The default user name and password are as follows.
User name: admin
Password: 12345



Connect to 192.168.0.10

Panasonic network device

User name:

Password:

Remember my password

OK Cancel

5. Click the [OK] button.

→ The “Live” page will be displayed. Refer to [VT164W](#) [VT164](#): page 10, [VP104W](#) [VP104](#) [VP101](#): page 15 for further information about the “Live” page.

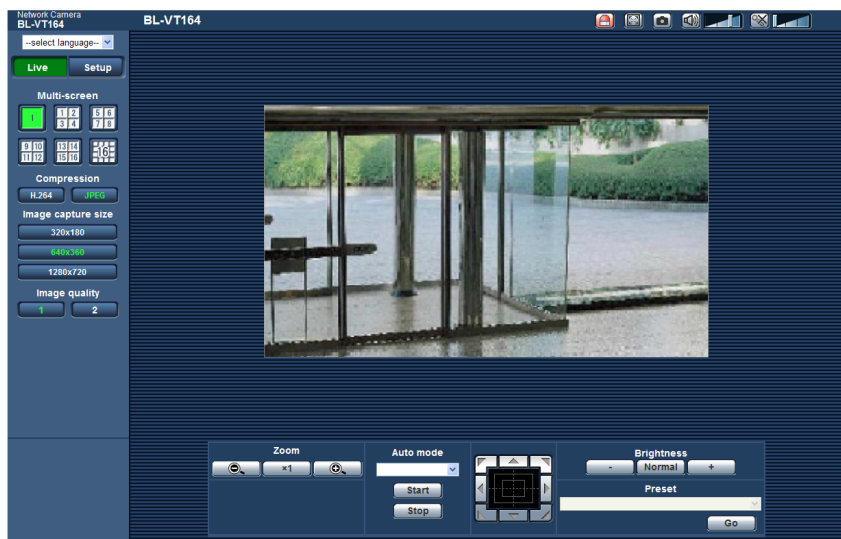

When “Off” is selected for “User auth.”, the authentication window will not be displayed before displaying live images. However, when the [Setup] button is clicked, an authentication window is displayed. A user name and password must be entered.

The default user name and password are as follows.

User name: admin

Password: 12345

IMPORTANT

- To enhance the security, change the password for the user name “admin”. It is recommended to change this password periodically.
- When displaying multiple H.264 images on a PC, images may not be displayed depending on the performance of the PC.

Note

- The maximum number of concurrent access user is 14 including users who is receiving H.264 images and users who are receiving JPEG images. Depending on the set values for “Bandwidth control(bit rate)” and “Max bit rate (per client)*”, the maximum concurrent access number may be 14 or less users. When 14 users are concurrently accessing, the access limit message will be displayed for users who subsequently attempt to access. When “Multicast” is selected for “Transmission type” of “H.264”, only the first user who accessed to monitor H.264 images will be included in the maximum number. The second and subsequent users who are monitoring H.264 images will not be included in the maximum number.
- Regardless of whether “On” or “Off” is selected for “H.264 transmission”, the first images displayed are JPEG images.
- The refresh interval may become longer depending on a network environment, PC performance, photographic subject, access traffic, etc.
 - <Refresh interval of JPEG images>**
 - When “H.264 transmission” is operating: max. 5 fps
 - When “H.264 transmission” is not operating (or stopped): max. 30 fps

1.2 About the “Live” page (BL-VT164W/BL-VT164)

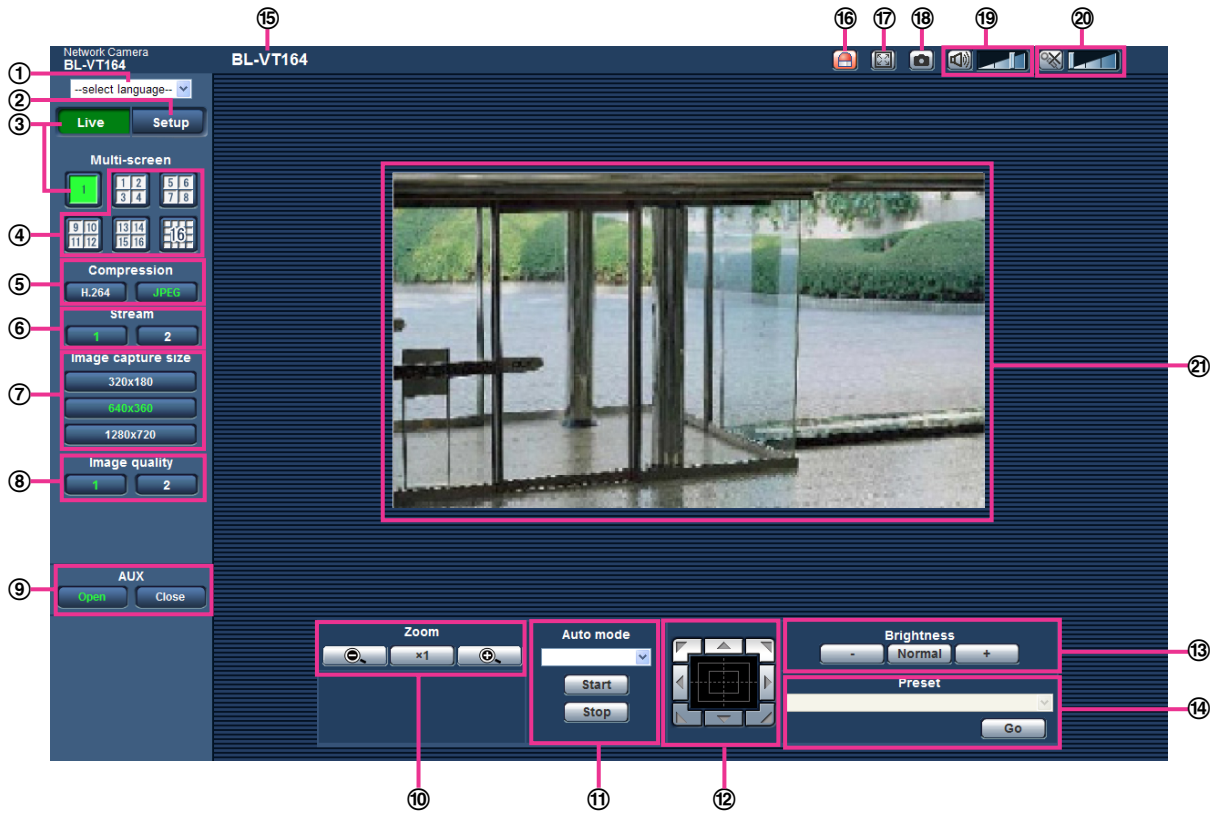

- ① **[select language] pull-down menu**
The camera's display language can be selected. The default language can be set in the [Language] in the [Basic] settings. (→page 39)
- ② **[Setup] button**
Displays the setup menu. The button will turn green and the setup menu will be displayed.
- ③ **[Live] button**
Display the “Live” page. The button will turn green and the “Live” page will be displayed.
- ④ **[Multi-screen] buttons**
Images from multiple cameras can be displayed on a multi-screen by registering cameras on the setup menu. (→page 18)
- ⑤ **[Compression] buttons**
 - **[H.264] button:** The letters “H.264” on the button will turn green and an H.264 image will be displayed. When “On” is selected for “H.264 transmission” of “H.264(1)”, “H.264(2)”, the [H.264] button will be displayed. (→page 51)
 - **[JPEG] button:** The letters “JPEG” on the button will turn green and JPEG image will be displayed.
- ⑥ **[Stream] buttons**
These buttons will be displayed only when an H.264 image is displayed.
 - **[1] button:** The letter “1” will turn green and images in the main area will be displayed in accordance with the setting of “H.264(1)”. (→page 51)
 - **[2] button:** The letter “2” will turn green and images in the main area will be displayed in accordance with the setting of “H.264(2)”. (→page 51)
- ⑦ **[Image capture size] buttons**
These buttons will be displayed only when a JPEG image is displayed.

[VGA]	The letters "VGA" will turn green and images in the main area will be displayed in VGA size.
[QVGA]	The letters "QVGA" will turn green and images in the main area will be displayed in QVGA size.
[640x360]	The letters "640x360" will turn green and images in the main area will be displayed in 640 x 360 (pixels).
[320x180]	The letters "320x180" will turn green and images in the main area will be displayed in 320 x 180 (pixels).
[800x600]	The letters "800x600" will turn green and images in the main area will be displayed in 800 x 600 (pixels).
[1280x720]	The letters "1280x720" will turn green and images in the main area will be displayed in 1280 x 720 (pixels).

Note

- When "1280x720" is selected for the image capture size, it may become smaller than the actual size depending on the window size of the web browser.
- The buttons [VGA], [QVGA] and [800x600] are displayed only when "4:3" is selected for "Aspect ratio".
- The buttons [640x360], [320x180], and [1280x720] are displayed only when "16:9" is selected for "Aspect ratio".

⑧ [Image quality] buttons

These buttons will be displayed only when a JPEG image is displayed.

- **[1] button:** Images in the main area will be displayed in accordance with the setting for "Quality1" of "Image quality setting". (→page 47)
- **[2] button:** Images in the main area will be displayed in accordance with the setting for "Quality2" of "Image quality setting". (→page 47)

⑨ [AUX] buttons²



These buttons will be displayed only when "AUX output" is selected for "Terminal 3" of "Alarm" on the setup menu. (→page 77)

- **[Open] button:** The letters "Open" on the button will turn green and the status of AUX connector will be open.
- **[Close] button:** The letters "Close" on the button will turn green and the status of the AUX connector will be closed.

Note

- The names of "AUX", "Open" and "Close" can be changed. (→page 83)

⑩ [Zoom] buttons²

- : Click this button to adjust the zoom ratio to the "Wide" side.
- : Click this button to set the zoom ratio to x1.0.
- : Click this button to adjust the zoom ratio to the "Tele" side.

⑪ [Auto mode]²

Select an operation from the pull-down menu and click the [Start] button. The selected operation will start. Click the [Stop] button to stop the operation.

The selected operation will stop when the camera (panning/tilting/zooming) is operated or when an action that is to be taken according to the settings for "Self return" (→page 55) or for "Camera action on alarm" (→page 79) starts.

- **Preset map-shot:** Eight thumbnail images of the preset position 1-8 (→page 65) will be displayed orderly on a newly displayed window. When a thumbnail image is clicked, the camera moves to the respective position and live images will be displayed on the “Live” page.

Note

- Do not operate the browser until all the thumbnail images are displayed and the camera returns to the original position (where the camera was when “360 map-shot” or “Preset map-shot” was carried out).
- When “Preset map-shot” is carried out with an unregistered preset position (among preset position 1-8), the thumbnail image of the preset position before the unregistered preset position will be displayed.
In this case, the camera will not move when the thumbnail image is clicked.
- The camera will not always return to the exactly same position where it was before “Preset map-shot” was carried out. (It may sometimes be slightly different.)
- The window on which the thumbnail images are displayed will close when clicking the following buttons that can switch the camera channel or reload images: [Live], [Multi-screen], [H.264], [JPEG], [Stream], [Image capture size], [Image quality], [Setup].
To display the thumbnail images again, carry out “Preset map-shot” again.

⑫ Control pad/buttons²

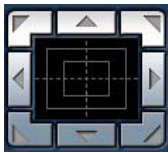

- : Left-click on the control pad to adjust the horizontal/vertical position of the camera

(panning/tilting). Panning/tilting speed will be faster if a clicked point gets farther from the center point of the control pad.



It is also possible to pan/tilt the camera by dragging the mouse.

Zoom can be adjusted by right-clicking. When an upper/lower area of the control pad is right-clicked, the displayed image will be zoomed in/out on.

Zoom can also be adjusted using the mouse wheel.

⑬ [Brightness] buttons²

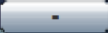
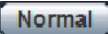
Available range: 0 - 127

-  **button:** The displayed image will be darker.
-  **button:** The adjusted brightness will return to the default brightness (64).
-  **button:** Image will be brighter.

⑭ [Preset]²

Select a preset position from the pull-down menu and click the [Go] button. The camera will move to the selected preset position (→page 65). “H” next to the preset position number indicates the home position. When “Home position” is selected, the camera will move to the home position. (→page 55) When “Preset ID” is registered for a preset position, the registered preset ID will be displayed next to the preset position number.

⑮ Camera title

The camera title entered for “Camera title” on the [Basic] page will be displayed. (→page 39)

⑯ Alarm occurrence indication button²

This button will be displayed and will blink when an alarm has occurred. When this button is clicked, the alarm output terminal will be reset and this button will disappear. (→page 30)

⑰ Full screen button

Images will be displayed on a full screen. To return to the “Live” page, press the [Esc] key. The aspect ratio of displayed images will be adjusted in accordance with the monitor.

18 Snap shot button

Click this button to take a picture (a still picture). The picture will be displayed on a newly opened window. When right-clicking on the displayed image, the pop-up menu will be displayed. It is possible to save the image on the PC by selecting "Save" from the displayed pop-up menu. When "Print" is selected, printer output is enabled.

Note

- The following setting may be necessary when using Windows 7 or Windows Vista. Click "Internet Options" on the Tools menu of Internet Explorer, and then click the [Security] tab. Select "Trusted Sites", and click "Sites". Register the camera address on the "Website" in the "Trusted Sites" window.

19 Mic input button³

Turns on/off the audio reception (hear audio from the camera on a PC). This button will be displayed only when "Mic input", "Interactive(Full-duplex)" or "Interactive(Half-duplex)" is selected for "Audio transmission/reception" on the setup menu. (→page 72)

When this button is clicked, the button will turn into the  button and audio from the camera will not be heard.

Audio volume can be adjusted (Low/ Middle/ High) by moving the volume cursor .

20 Audio output button³

Turns on/off the audio transmission (play audio from the PC on the unit speaker). This button will be displayed only when "Audio output", "Interactive(Full-duplex)" or "Interactive(Half-duplex)" is selected for "Audio transmission/reception" on the setup menu. (→page 72)

The button will blink during the audio transmission.

When this button is clicked, the button will turn into the  button and audio from the PC will not be heard.

Audio output volume can be adjusted (Low/Middle/High) by moving the volume cursor .

Note

- When a user is using the audio transmission function with "Interactive(Half-duplex)" selected, the receiver button and the transmission button will be inoperable for the other users. When "Interactive(Full-duplex)" is selected, the transmission button is inoperable for other users.
- Possible duration of audio transmission is up to 5 minutes per transmission. When 5 minutes have passed, the audio transmission will automatically stop. To turn the audio transmission function on, click the [Audio output] button again.
- When the camera is restarted, the adjusted volume level (for both the audio transmission and reception) will return to the level that had been set on the [Audio] tab on the setup menu. (→page 72)
- Actual volume level will change in three steps even though the volume cursor can be adjusted minutely.

21 Main area²

Images from the camera will be displayed in this area.

The current time and date will be displayed according to the settings configured for "Time display format" and "Date/time display format". (→page 40)

In addition, when being adjusted, the status of brightness (→page 41), panning/tilting degree and the zoom ratio display (→page 56), and the preset ID (→page 67) will be displayed as well as the characters configured for "Camera title on screen" (→page 40). The number of lines for the display is 2.

Click a desired point in the main area on the "Live" page that is to be the center of the angle of view. The camera moves to adjust the position in order to set the clicked point as the center.

When selecting an area in the main area by dragging the mouse, the selected area will be located at the center of the main area. In this case, the zoom ratio will be adjusted automatically.

Zoom can be adjusted using the mouse wheel.

Note

- When operated by a lower access level user, images displayed on the screen may be changed temporarily. This does not affect operation of the camera.
- When the mouse is dragged to move the camera beyond its operable range, the camera will move to the requested direction and will stop at the end of the operable range. Then, the zoom ratio of the displayed image will automatically be adjusted.
- Depending on the PC in use, screen tearing* may occur when the shooting scene drastically changes due to the GDI restrictions of the OS.
*A phenomenon in which portions of the screen are displayed out of alignment.

^{*1} Only operable by users whose access level is "1. Administrator".

^{*2} Only operable by users whose access level is "1. Administrator" or "2. Camera control" when "On" is selected for "User auth."
(→page 94)

^{*3} Operable by users who belong to the access level selected for "Permission level of audio trans./recep." on the [Audio] tab of the "Image/Audio" page. Refer to page 72 for further information about the "Permission level of audio trans./recep.".

1.3 About the “Live” page (BL-VP104W/BL-VP104/BL-VP101)

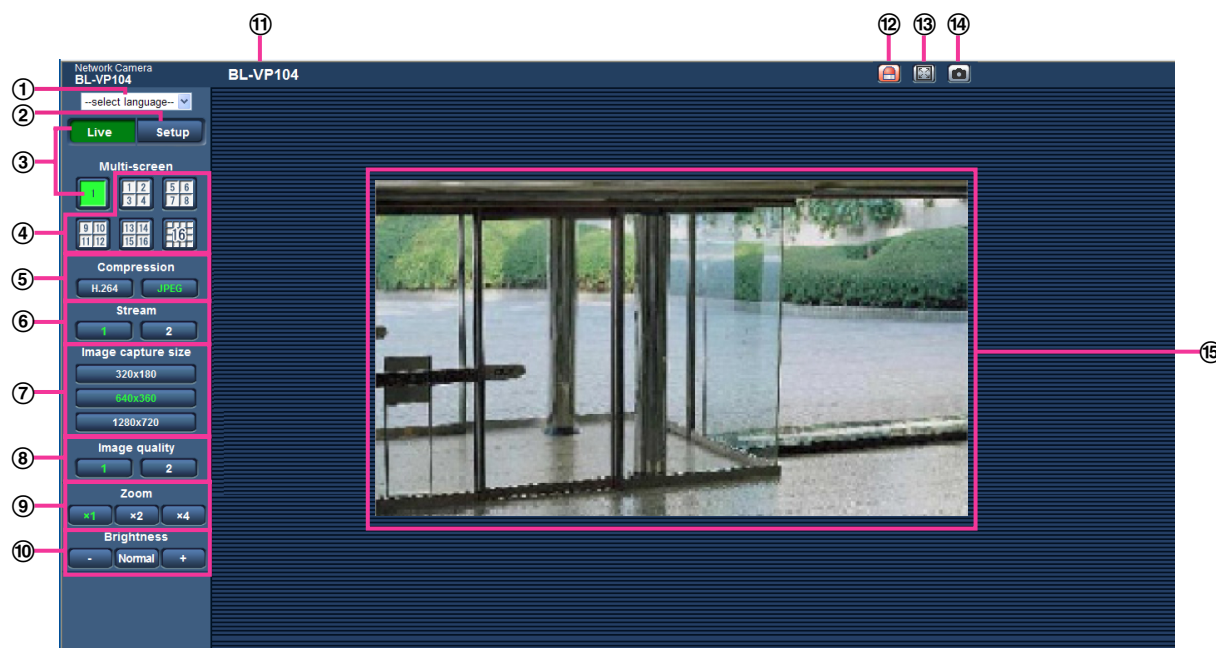

① [select language] pull-down menu

The camera's display language can be selected. The default language can be set in the [Language] in the [Basic] settings. (→page 39)

② [Setup] button¹

Displays the setup menu. The button will turn green and the setup menu will be displayed.

③ [Live] button

Display the “Live” page. The button will turn green and the “Live” page will be displayed.

④ [Multi-screen] buttons

Images from multiple cameras can be displayed on a multi-screen by registering cameras on the setup menu. (→page 18)

⑤ [Compression] buttons

- **[H.264] button:** The letters “H.264” on the button will turn green and an H.264 image will be displayed. When “On” is selected for “H.264 transmission” of “H.264(1)”, “H.264(2)”, the [H.264] button will be displayed. (→page 51)
- **[JPEG] button:** The letters “JPEG” on the button will turn green and JPEG image will be displayed.

⑥ [Stream] buttons

These buttons will be displayed only when an H.264 image is displayed.



- **[1] button:** The letter “1” will turn green and images in the main area will be displayed in accordance with the setting of “H.264(1)”. (→page 51)
- **[2] button:** The letter “2” will turn green and images in the main area will be displayed in accordance with the setting of “H.264(2)”. (→page 51)

⑦ [Image capture size] buttons

These buttons will be displayed only when a JPEG image is displayed.

[VGA]

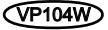
The letters “VGA” will turn green and images in the main area will be displayed in VGA size.

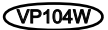
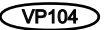
[QVGA]	The letters "QVGA" will turn green and images in the main area will be displayed in QVGA size.
[640x360]	The letters "640x360" will turn green and images in the main area will be displayed in 640 x 360 (pixels).
[320x180]	The letters "320x180" will turn green and images in the main area will be displayed in 320 x 180 (pixels).
[800x600]  	The letters "800x600" will turn green and images in the main area will be displayed in 800 x 600 (pixels).
[1280x720]  	The letters "1280x720" will turn green and images in the main area will be displayed in 1280 x 720 (pixels).

Note

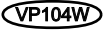
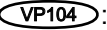
- The buttons [VGA], [QVGA] and [800x600] are displayed only when "4:3" is selected for "Aspect ratio".
- The buttons [640x360], [320x180], and [1280x720] are displayed only when "16:9" is selected for "Aspect ratio".
-  :
 - When "1280x720" is selected for the image capture size, it may become smaller than the actual size depending on the window size of the web browser.

⑧ **[Image quality] buttons**

These buttons will be displayed only when a JPEG image is displayed.

- **[1] button:** Images in the main area will be displayed in accordance with the setting for "Quality1" of "Image quality setting". (→page 47)
- **[2] button:** Images in the main area will be displayed in accordance with the setting for "Quality2" of "Image quality setting". (→page 47)



⑨ **[Zoom] buttons**

Images will be zoomed in on with the electronic zoom by the viewer software "Network Camera View 4S".

- **[x1] button:** The letter "x1" will turn green and images in the main area will be displayed at x1.
- **[x2] button:** The letter "x2" will turn green and images in the main area will be displayed at x2.
- **[x4] button:** The letter "x4" will turn green and images in the main area will be displayed at x4.

⑩ **[Brightness] buttons²**

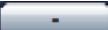
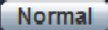
Available range: 0 - 127

-  **button:** The displayed image will be darker.
-  **button:** The adjusted brightness will return to the default brightness (64).
-  **button:** Image will be brighter.

⑪ **Camera title**

The camera title entered for "Camera title" on the [Basic] page will be displayed. (→page 39)

⑫ **Alarm occurrence indication button²**

This button will be displayed and will blink when an alarm has occurred. When this button is clicked, the alarm output terminal will be reset and this button will disappear. (→page 30)

⑬ **Full screen button**

Images will be displayed on a full screen. To return to the "Live" page, press the [Esc] key. The aspect ratio of displayed images will be adjusted in accordance with the monitor.

⑭ **Snap shot button**

Click this button to take a picture (a still picture). The picture will be displayed on a newly opened window. When right-clicking on the displayed image, the pop-up menu will be displayed. It is possible to save the image on the PC by selecting "Save" from the displayed pop-up menu. When "Print" is selected, printer output is enabled.

Note

- The following setting may be necessary when using Windows 7 or Windows Vista. Click “Internet Options” on the Tools menu of Internet Explorer, and then click the [Security] tab. Select “Trusted Sites”, and click “Sites”. Register the camera address on the “Website” in the “Trusted Sites” window.

⑮ Main area²

Images from the camera will be displayed in this area.

The current time and date will be displayed according to the settings configured for “Time display format” and “Date/time display format”. (→page 40)

In addition, when being adjusted, the status of brightness (→page 41), panning/tilting degree and the zoom ratio display (→page 56), and the preset ID (→page 67) will be displayed as well as the characters configured for “Camera title on screen” (→page 40). The number of lines for the display is 2.

Click a desired point in the main area on the “Live” page that is to be the center of the angle of view. The camera moves to adjust the position in order to set the clicked point as the center.

When selecting an area in the main area by dragging the mouse, the selected area will be located at the center of the main area. In this case, the zoom ratio will be adjusted automatically.

Zoom can be adjusted using the mouse wheel.

Note

- When operated by a lower access level user, images displayed on the screen may be changed temporarily. This does not affect operation of the camera.
- When the mouse is dragged to move the camera beyond its operable range, the camera will move to the requested direction and will stop at the end of the operable range. Then, the zoom ratio of the displayed image will automatically be adjusted.
- Depending on the PC in use, screen tearing* may occur when the shooting scene drastically changes due to the GDI restrictions of the OS.

*A phenomenon in which portions of the screen are displayed out of alignment.

¹ Only operable by users whose access level is “1. Administrator”.

² Only operable by users whose access level is “1. Administrator” or “2. Camera control” when “On” is selected for “User auth.” (→page 94)

1.4 Monitor images from multiple cameras

Images from multiple cameras can be displayed on a multi-screen. Images from 4 cameras (up to 16 cameras) can be displayed simultaneously. To display images on a multi-screen, it is necessary to register cameras in advance. 4 cameras can be registered as a group and up to 4 groups (16 cameras) can be registered. (→page 75)

IMPORTANT

- When displaying images on a 16-screen, panning, tilting and zooming operations become unavailable for images from cameras with Pan/Tilt/Zoom functions.
- When displaying images on a 4-screen, panning, tilting and zooming operations become available only for images from cameras with Pan/Tilt/Zoom functions. Refer to the [Readme] file on the provided CD-ROM for further information about the compatible cameras and their versions. Or refer to our website (<http://panasonic.net/pss/security/support/info.html>).
- Only JPEG images with frame by frame playback can be displayed on a multi-screen. Audio will not be heard.
- When the power is turned off or the LAN cable is disconnected while displaying images, displaying images on a multi-screen from the “Live” page will become unavailable.
- When displaying the image on a multi-screen and “16:9” is selected for “Aspect ratio”, the image will be displayed altered vertically to the aspect ratio of “4:3”.
- “Network Camera Recorder with Viewer Software Lite” which supports live monitoring and recording images from multiple cameras is available. For further information, refer to our website (<http://panasonic.net/pss/security/support/info.html>).

1. Click the desired [Multi-screen] on the “Live” page.

→ Images from the registered cameras will be displayed on a selected multi-screen (screen can be split up to 16 areas). The following are instructions when displaying on a 4-split screen.

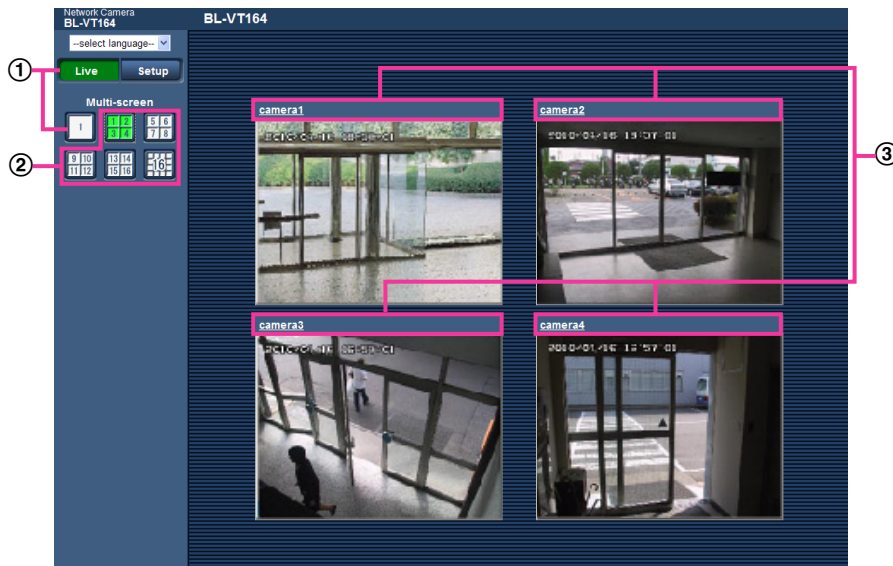

- ① To show 1 camera screen, click the [Live] button.
You can also click “1” below “Multi-screen” to display the camera's “Live” page.
- ② Click the [Multi-screen] button to display images from cameras in a multi-screen of 4 to 16 screens.
- ③ Click a camera title. Live images from the camera corresponding to the clicked camera title will be displayed on the “Live” page of the newly opened window.

2 Monitor images on a cellular phone/mobile terminal

2.1 Monitor images on a cellular phone

It is possible to connect to the camera using a cellular phone via the Internet and monitor images (JPEG only) from the camera on the screen of the cellular phone. It is also possible to refresh images to display the latest image or perform panning, tilting and zooming operations.

IMPORTANT

- When the authentication window is displayed, enter the user name and password. The default user name and password are as follows.
User name: admin
Password: 12345
To enhance the security, change the password for the user “admin”. (→page 94)
- If the cellular phone in use is not compatible with UTF-8 encode, it is impossible to display the screen correctly.

Note

- It is necessary to configure the network settings of the cellular phone in advance to connect to the Internet and monitor images from the camera. (→page 104)

2 Monitor images on a cellular phone/mobile terminal

1. Access to "http://IP address/mobile" or "http://Host name registered in the DDNS server/mobile" using a cellular phone.
→ Images from the camera will be displayed.

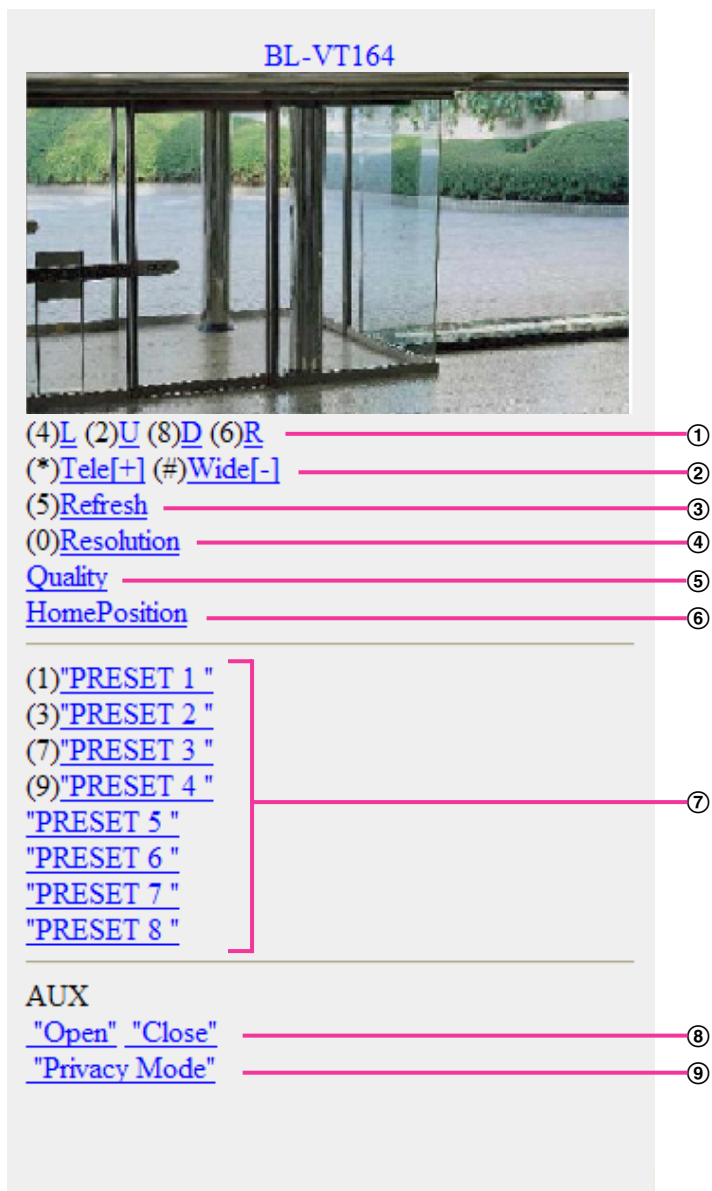

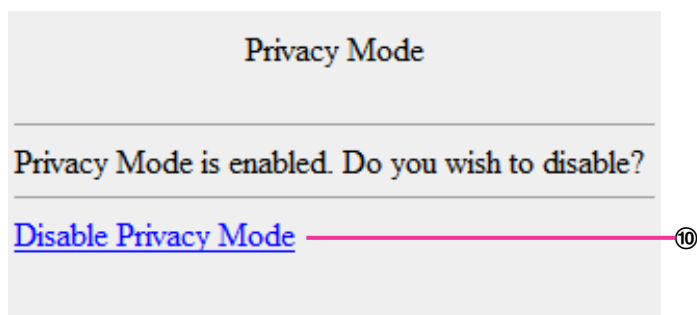

Functions	Outline of functions
① Pan/tilt ² VT164W VT164	Controls the camera direction. The camera will pan or tilt to each direction by pressing the corresponding dial key.
② Zooming control ² VT164W VT164	It is possible to perform zooming operations of the camera by pressing “*” or “#”.
③ Refresh	Refreshes the camera images by pressing the dial key “5”.
④ Resolution control	Changes the image capture size by pressing the dial key “0”. <ul style="list-style-type: none"> Image in the aspect ratio of “4:3” Changes the image capture size between 320x240 (default) and 640x480.
	<ul style="list-style-type: none"> Image in the aspect ratio of “16:9” Changes the image capture size between 320x180 (default) and 640x360. <p>Note</p> <ul style="list-style-type: none"> Some cellular phones cannot change the image capture size even when resolution is changed by resolution control.
⑤ Image quality control	It is possible to change the image quality between “Quality1” and “Quality2”. (→page 47)
⑥ Home position ² VT164W VT164	The camera will move to the home position (→page 55). Home position will be displayed only when home position is set.
⑦ Preset ² VT164W VT164	The camera will move to the designated preset position to display images by pressing the dial key corresponding to the desired channel. (The dial key numbers are not displayed for Preset No 5 or greater. Only preset IDs will be displayed for them.) (→page 65)
⑧ AUX control ² VT164W VT164	Controls the AUX terminal. These buttons will be displayed only when “AUX output” is selected for “Terminal 3” on the setup menu. (→page 77)
⑨ Privacy Mode VT164W VT164	Select “Privacy Mode” to activate Privacy mode.
⑩ Disable Privacy Mode VT164W VT164	Select “Disable Privacy Mode” to return to the normal display.

2 Monitor images on a cellular phone/mobile terminal

Note

- When the HTTP port number is changed from “80”, enter “http://IP address: (colon) + port number/mobile”¹ in the address box of the browser. When using the DDNS function, access to “http://Host name registered in the DDNS server: (colon) + port number/mobile”.
- When “HTTPS” is selected for “HTTPS” - “Connection” on the [Network] tab of the “Network” page, enter as follows.
“https://IP address: (colon) + port number/mobile” or “https://Host name registered in the DDNS server: (colon) + port number/mobile”
- When the authentication window is displayed, enter the user name of an administrator or user and password. Depending on the cellular phone in use, password entry may be required each time the screen is switched.
- It is impossible to transmit/receive audio using a cellular phone.
- Depending on the cellular phone in use, larger size images may not be displayed. In this case, selecting “9 Low” for “Image quality setting” of “JPEG” (→page 47) may sometimes solve this problem.
- Depending on the cellular phone in use or its contract plan, it may be impossible to access.

¹ IP address is the global WAN IP address of the router that can be accessed via the Internet.

² Only displayed for users whose access level is “1. Administrator” or “2. Camera control” when “On” is selected for “User auth.”. (→page 94)

2.2 Monitor images on a mobile terminal

It is possible to connect to the camera using a mobile terminal and monitor images (MJPEG only) from the camera on the screen of the mobile terminal. Images are automatically refreshed to display the latest image. Operations such as pan/tilt/zoom can also be performed.

The compatible mobile terminals are shown as follows. (As of January, 2012)

- iPad, iPhone, iPod touch (iOS 4.2.1 or later)
- Android™ mobile terminals

Only JPEG images can be viewed from standard Android mobile terminal browsers.

For further information about compatible devices, refer to our website (<http://panasonic.net/pss/security/support/info.html>).

IMPORTANT

- When the authentication window is displayed, enter the user name and password. The default user name and password are as follows.
User name: admin
Password: 12345
To enhance the security, change the password for the user “admin”. (→page 94)

Note

- To view the camera images from a mobile terminal, network settings needed in order to connect to the Internet must be set in advance. (→page 104)

1. Access to “http://IP address/cam”¹ or “http://Host name registered in the DDNS server/cam”² using a mobile terminal.

→ Images from the camera will be displayed.

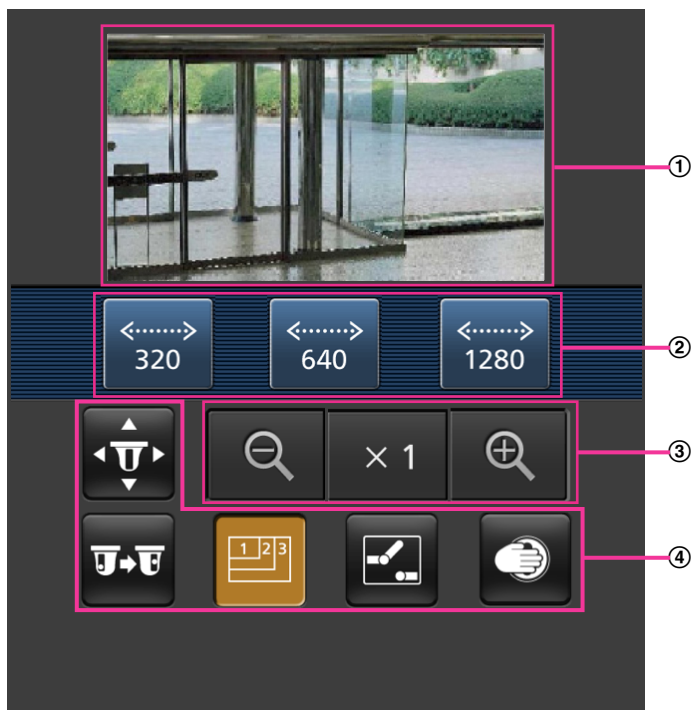

- ① Live images area
Displays images from the camera.
- ② Operation buttons area
When functions are selected in the function selection area ④, buttons to operate those functions are displayed.
- ③ Zoom operation area
Buttons to operate the zoom are displayed.
- ④ Function selection area
When functions that can be operated are selected, operation buttons are displayed in the operation buttons area ②.

2 Monitor images on a cellular phone/mobile terminal



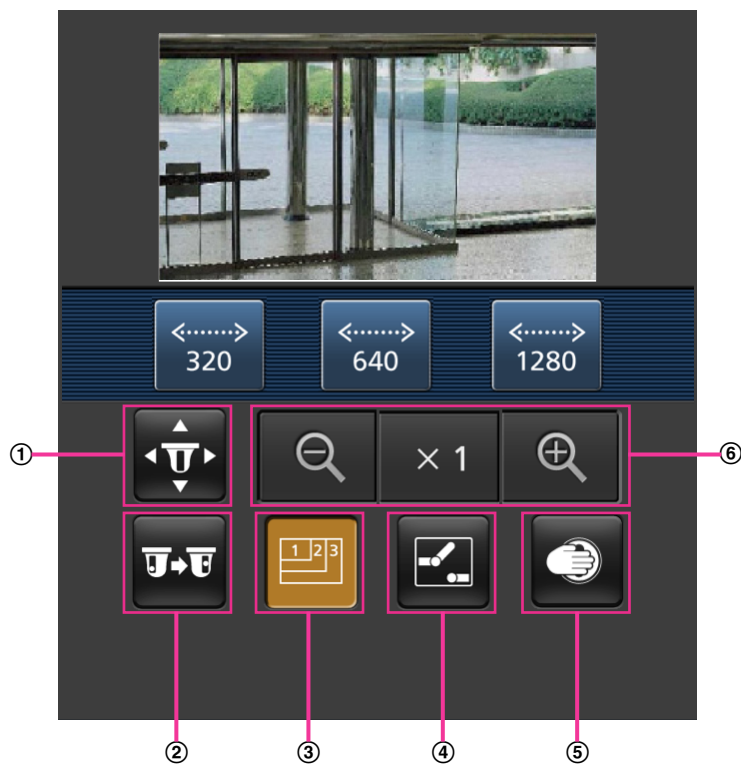

2. Click the button of the function that you want to operate.





- ① Pan/Tilt (VT164W) (VT164)
- ② Preset (VT164W) (VT164)
- ③ Resolution control
- ④ AUX control (VT164W) (VT164)
- ⑤ Privacy Mode control (VT164W) (VT164)
- ⑥ Zoom display (VT164W) (VT164)

Each function is explained below.

① Pan/Tilt **VT164W** **VT164**

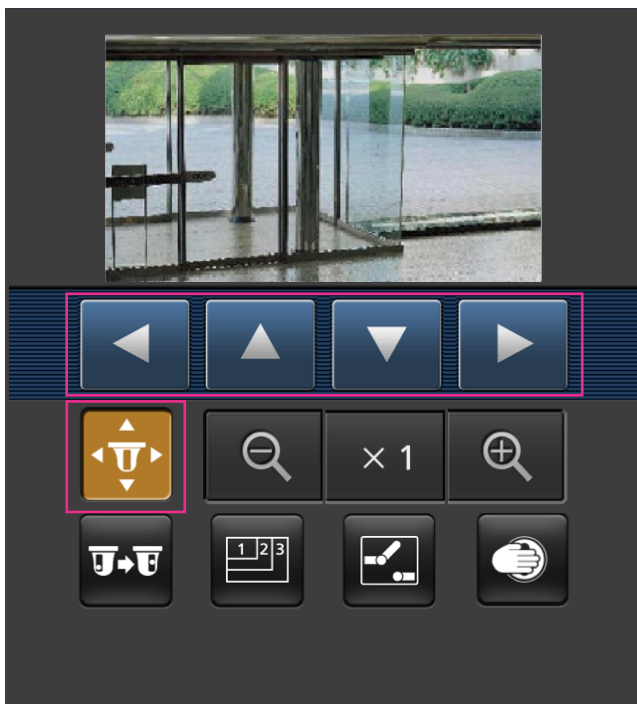
Press the  button to display the buttons used to operate pan/tilt on the screen. The pan/tilt can be adjusted in each direction with the , , , and  buttons.

② Preset **VT164W** **VT164**

Press the  button to display the buttons used to select the preset position on the screen. Camera images are displayed of the registered preset camera directions according to the preset numbers selected from the buttons.

- Only position numbers 1-4 for the preset positions are displayed.
- Only registered preset positions are displayed. Unregistered preset positions are not displayed.

2 Monitor images on a cellular phone/mobile terminal

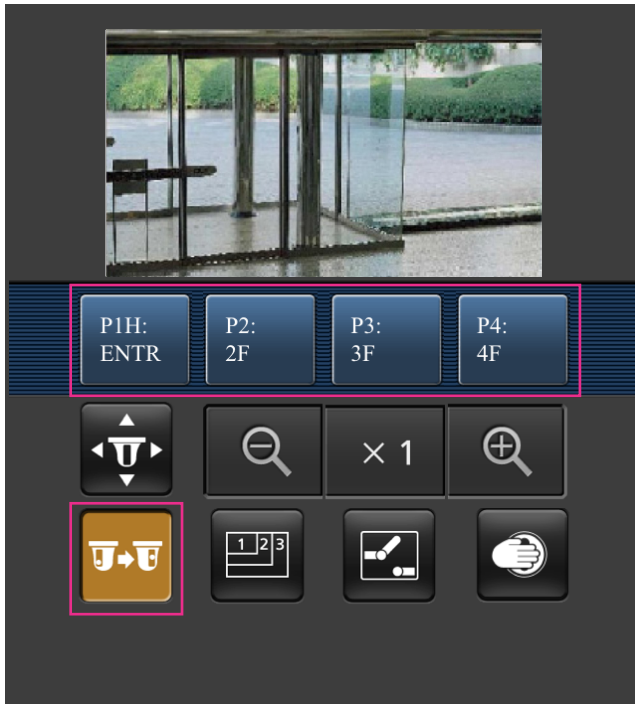

③ Resolution control

Press the  button to display the buttons used to select the resolution on the screen. The resolution can be changed by selecting a resolution setting from the buttons.

- **Image in the aspect ratio of "4:3"**

    :

Changes the image capture size between 320x240, 640x480 (default), and 800x600.

 :

Changes the image capture size between 320x240 and 640x480 (default).

- **Image in the aspect ratio of "16:9"**

    :



Changes the image capture size between 320x180, 640x360 (default), and 1280x720.

 :

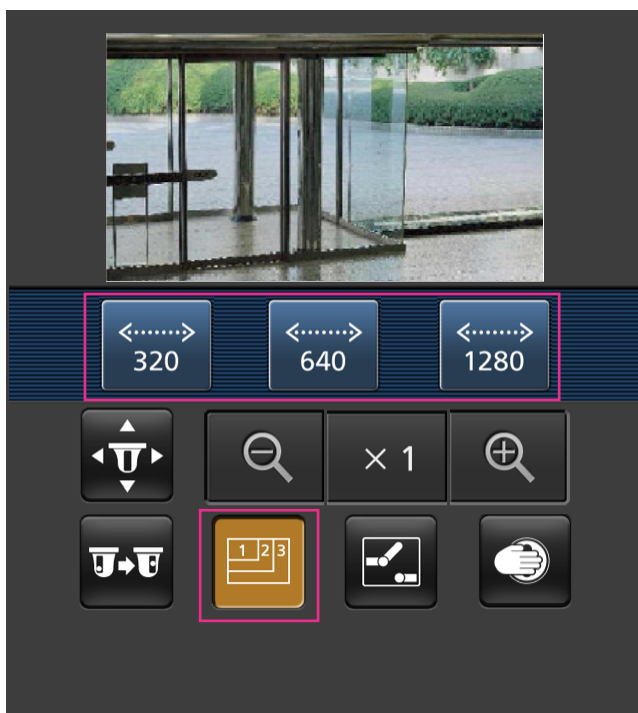
Changes the image capture size between 320x180 and 640x360 (default).



④ AUX control **VT164W** **VT164**

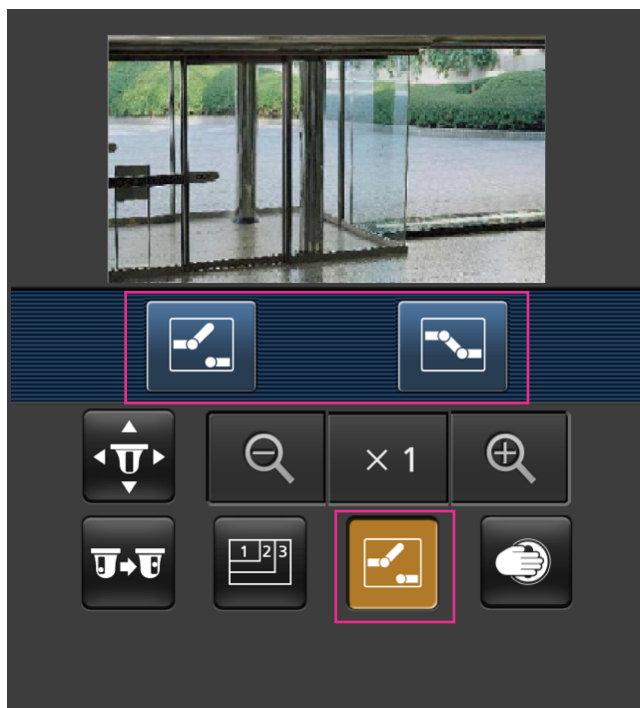

Press the  button to display the buttons used to operate the AUX output on the screen. The AUX output terminals can be controlled with the  and  buttons.

This function is only displayed when [Terminal 3] is set to [AUX output] on the settings menu.
 (→page 77)



2 Monitor images on a cellular phone/mobile terminal

⑤ Privacy Mode control **VT164W** **VT164**

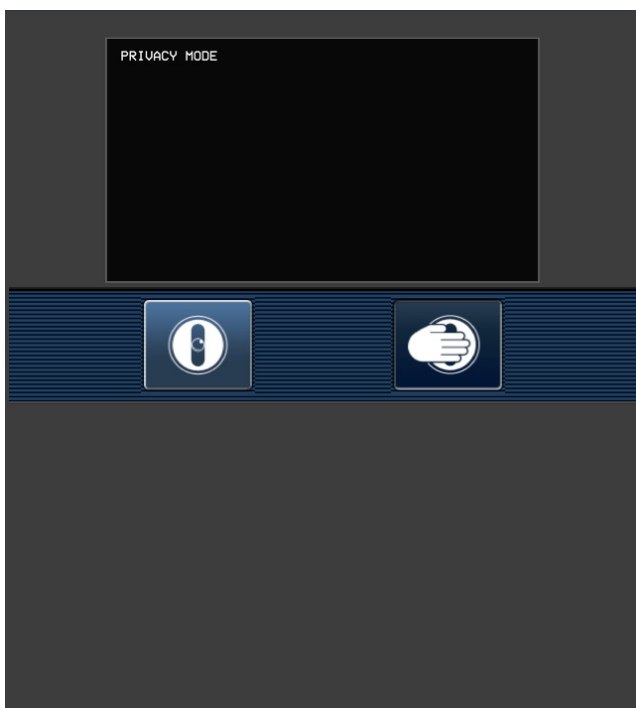
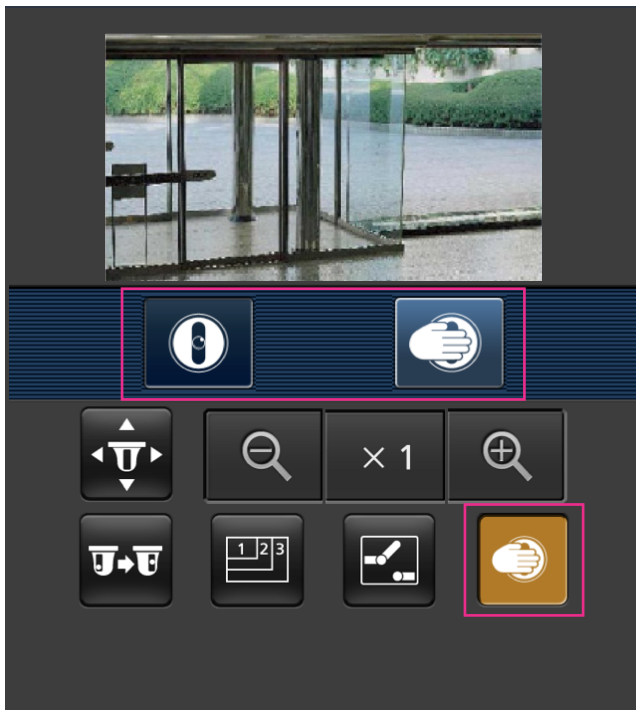

Press the  button to display the buttons used to operate the privacy mode on the screen. The privacy mode can be enabled and disabled with the  and  buttons.



To activate privacy mode, press .

To deactivate privacy mode, press .

⑥ Zoom display **VT164W** **VT164**

The camera's zoom can be operated with the , , and  buttons.

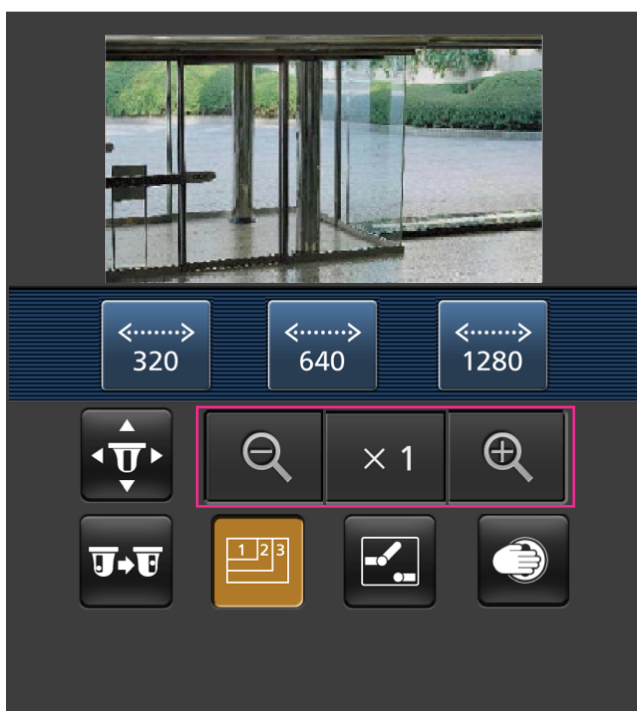
**Note**

- You can change the image size displayed on the mobile terminal by accessing the following addresses.
 - Large display: <http://IP address/cam/dl>
 - Medium display: <http://IP address/cam/dm>
 - Small display: <http://IP address/cam/ds>
- When the resolution is changed by the resolution control, the displayed resolution changes but the image size remains the same.
- When the HTTP port number is changed from "80", enter "[http://IP address: \(colon\) + port number/cam](http://IP address: (colon) + port number/cam)"¹ in the address box of the browser. When using the DDNS function, access to "[http://Host name registered in the DDNS server: \(colon\) + port number/cam](http://Host name registered in the DDNS server: (colon) + port number/cam)"².
- When "HTTPS" is set in "HTTPS" - "Connection" on the [Network] tab of the "Network" page, enter the following:
 - [https://IP address: \(colon\) + port number/cam](https://IP address: (colon) + port number/cam) or [https://Host name registered in the DDNS server: \(colon\) + port number/cam](https://Host name registered in the DDNS server: (colon) + port number/cam).
- When the authentication window is displayed, enter the user name of an administrator or user and password. Depending on the mobile terminal in use, password entry may be required each time the screen is switched.
- It is impossible to transmit/receive audio using a mobile terminal.
- Depending on the mobile terminal in use, larger size images may not be displayed. In this case, selecting "9 Low" for "Image quality setting" of "JPEG" (→page 47) may sometimes solve this problem.
- Depending on the mobile terminal in use or its contract plan, it may be impossible to access.

¹ IP address is the global WAN IP address of the router that can be accessed via the Internet. However, when accessing the same LAN as the camera with a wireless compatible mobile terminal, the IP address is the local IP address.

² Only when accessing the camera through the Internet.

3 Action at an alarm occurrence

The alarm action (camera action at an alarm occurrence) will be performed when the following alarms occur.

3.1 Alarm type

- **Terminal alarm** (VT164W) (VT164): When connecting an alarm device such as a sensor to the EXT I/O connectors 1-3 of the camera, the alarm action will be performed when the connected alarm device is activated.
- **Body heat sensor** (VT164W) (VT164): When a temperature difference is detected in the sensor's detection area, the alarm action will be performed.
- **VMD alarm**: When motion is detected in the set VMD area, the alarm action will be performed.
*VMD stands for "Video Motion Detection".
- **Command alarm**: When a Panasonic alarm protocol is received from the connected device via a network, the alarm action will be performed.

3.2 Action at an alarm occurrence

Display the alarm occurrence indication button on the "Live" page

The alarm occurrence indication button will be displayed on the "Live" page at an alarm occurrence. (→ (VT164W) (VT164): page 10, (VP104W) (VP104) (VP101): page 15)

IMPORTANT

- When "Polling(30s)" is selected for "Alarm status update mode" (→page 39), the Alarm occurrence indication button will be refreshed in 30-second intervals. For this reason, it may take a maximum of 30 seconds until the alarm occurrence indication button is displayed on the "Live" page at an alarm occurrence.

Notify of alarm occurrences to the device connected to the alarm connector

It is possible to output signals from the alarm connector on the rear of the camera and sound the buzzer when an alarm occurs. The settings for the alarm output can be configured in the "Alarm output terminal setup" section of the [Alarm] tab of the "Alarm" page. (→page 77, page 82)

Transmit an image onto a server automatically

An alarm image can be transmitted at an alarm occurrence to the server designated in advance. The settings required to transmit an alarm image to a server can be configured in the "Alarm image" section on the [Alarm] tab of the "Alarm" page (→page 80) and the [FTP] tab (→page 100) of the "Server" page.

Notify of alarm occurrences by E-mail

Alarm E-mail (alarm occurrence notification) can be sent at an alarm occurrence to the E-mail addresses registered in advance. Up to 4 addresses can be registered as recipients of the alarm E-mail. An alarm image (still picture) can be sent with the alarm E-mail as an attached file. The settings for alarm E-mail can be configured in the "E-mail notification" section on the [Notification] tab of the [Alarm] page (→page 87) and the [E-mail] tab of the "Server" page (→page 99).

Notify of alarm occurrences to the designated IP addresses (Panasonic alarm protocol notification)

This function is available only when a Panasonic device, such as the network disk recorder, is connected to the system. When “On” is selected for “Panasonic alarm protocol”, the connected Panasonic device will be notified that the camera is in the alarm state. The settings for Panasonic alarm protocol can be configured in the Panasonic alarm protocol section of the [Notification] tab of the [Alarm] page. (→page 88)

4 Transmit images onto an FTP server

Images can be transmitted to an FTP server. By configuring the following settings, transmission of images captured at an alarm occurrence or captured at a designated interval to an FTP server will become available.

IMPORTANT

- When using this function, set the user name and the password to access the FTP server to restrict users who can log into the FTP server.

4.1 Transmit an alarm image at an alarm occurrence (Alarm image transmission)

An alarm image can be transmitted at an alarm occurrence to the FTP server. To transmit alarm images to an FTP server, it is necessary to configure the settings in advance.

The settings for the FTP server can be configured on the [FTP] tab of the “Server” page. (→page 100)

The alarm image transmission function can be turned on/off in the “Alarm image” section of the [Alarm] tab of the “Alarm” page. (→page 80)

Note

- Depending on the network traffic, the number of the transmitted images may not reach the set number of images to be transmitted.

4.2 Transmit images at a designated interval or period (FTP periodic image transmission)

Images can be transmitted at a designated interval or period. To transmit images at a designated interval or period, it is necessary to configure the settings in advance.

The settings for the FTP server can be configured on the [FTP] tab of the “Server” page. (→page 100)

It is possible to determine whether or not to use the FTP periodic image transmission function and to configure the settings relating to alarm images and the schedule on the [FTP img. trans.] tab of the “Network” page.

(→page 135)

Note

- Depending on the line speed or the traffic, images may not be transmitted at the designated interval.
- When “On” is selected for both the alarm image transmission function and the FTP periodic image transmission function, the alarm image transmission function will be given priority over the FTP periodic image transmission function. Therefore, images may not be transmitted at the interval designated on the “FTP periodic image transmission” setting.

5 About the network security

5.1 Equipped security functions

The following security functions are featured in this camera.

- ① Access restrictions by the host authentication and the user authentication
It is possible to restrict users from accessing the camera by setting the host authentication and/or the user authentication to "On". (→page 94, page 95)
- ② Access restrictions by changing the HTTP port
It is possible to prevent illegal access such as port scanning, etc. by changing the HTTP port number. (→page 107)
- ③ Access encryption by the HTTPS function
It is possible to enhance the network security by encrypting the access to cameras using the HTTPS function. (→page 112)

IMPORTANT

- Design and enhance security countermeasures to prevent leakage of information such as image data, authentication information (user name and password), alarm E-mail information, FTP server information, DDNS server information, etc. Perform the countermeasure such as access restriction (using the user authentication) or access encryption (using the HTTPS function).
- After the camera is accessed by the administrator, make sure to close the browser for added security.
- Change the administrator password periodically for added security.

Note

- When user authentication (authentication error) has failed to pass 8 times within 30 seconds using the same IP address (PC), access to the camera will be denied for a while.

6 Display the setup menu from a PC

The settings of the camera can be configured on the setup menu.

IMPORTANT

- The setup menu is only operable by users whose access level is “1. Administrator”. Refer to page 94 for how to configure the access level.

6.1 How to display the setup menu

1. Display the “Live” page. (→page 7)
2. Click the [Setup] button on the “Live” page.
When the authentication window is displayed, enter the user name and password, then click [OK].
The default user name and password are as follows.
User name: admin
Password: 12345
→ The setup menu will be displayed. Refer to page 37 for further information about this menu.

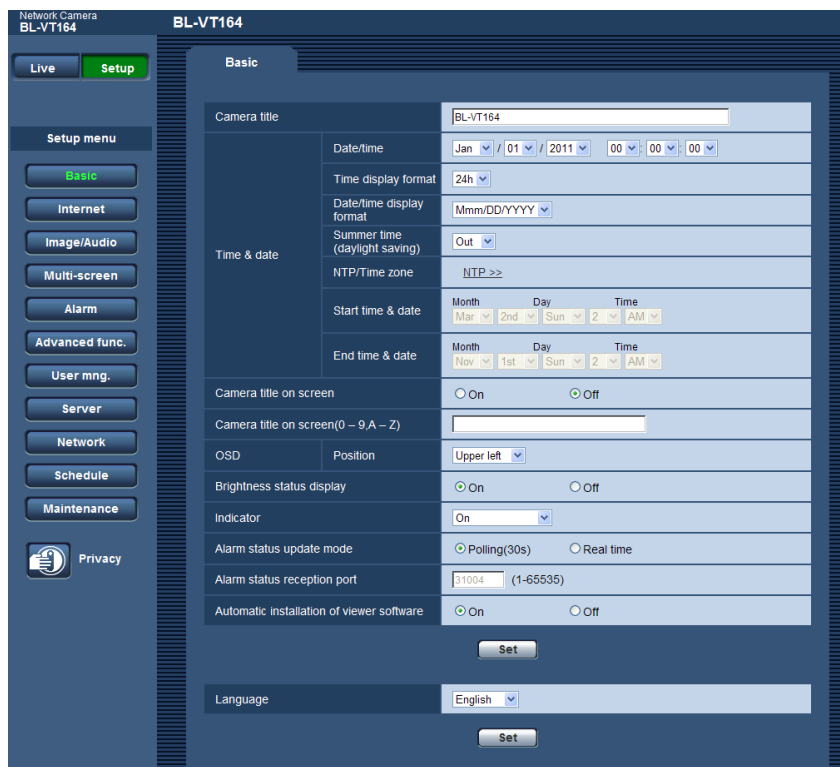

Note

- When “Off” is selected for “User auth.”, if the [Setup] button is clicked, an authentication window is displayed. A user name and password must be entered.
The default user name and password are as follows.
User name: admin
Password: 12345

6.2 How to operate the setup menu

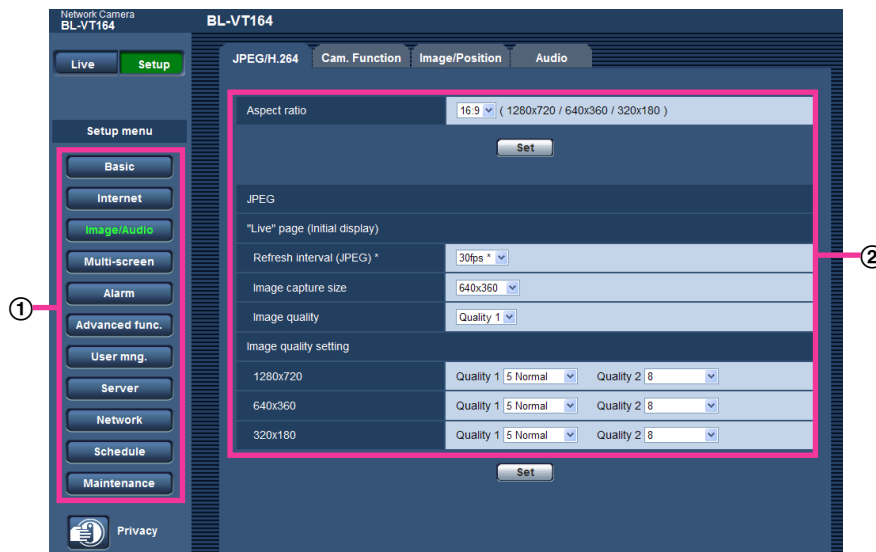

- ① Menu buttons
- ② Setup page

1. Click the desired button in the frame on the left of the window to display the respective setup menu. When there are tabs at the top of the "Setup" page displayed in the frame on the right of the window, click the desired tab to display and configure the setting items relating to the name of the tab.
2. Complete each setting item displayed in the frame on the right of the window.
3. After completing each setting item, click the [Set] button to apply them.

IMPORTANT

- When there are two or more [Set] and [Execute] buttons on the page, click the respective button to the edited setting item.

<Example>



When completing the setting items in field ①, click the [Set] button ② below field ①.

6 Display the setup menu from a PC

The edited settings in field ① will not be applied unless the [Set] button (②) below field (①) is clicked. In the same manner as above, click the [Set] button (④) below field ③ when completing the setting items in field ③.

6.3 About the setup menu window

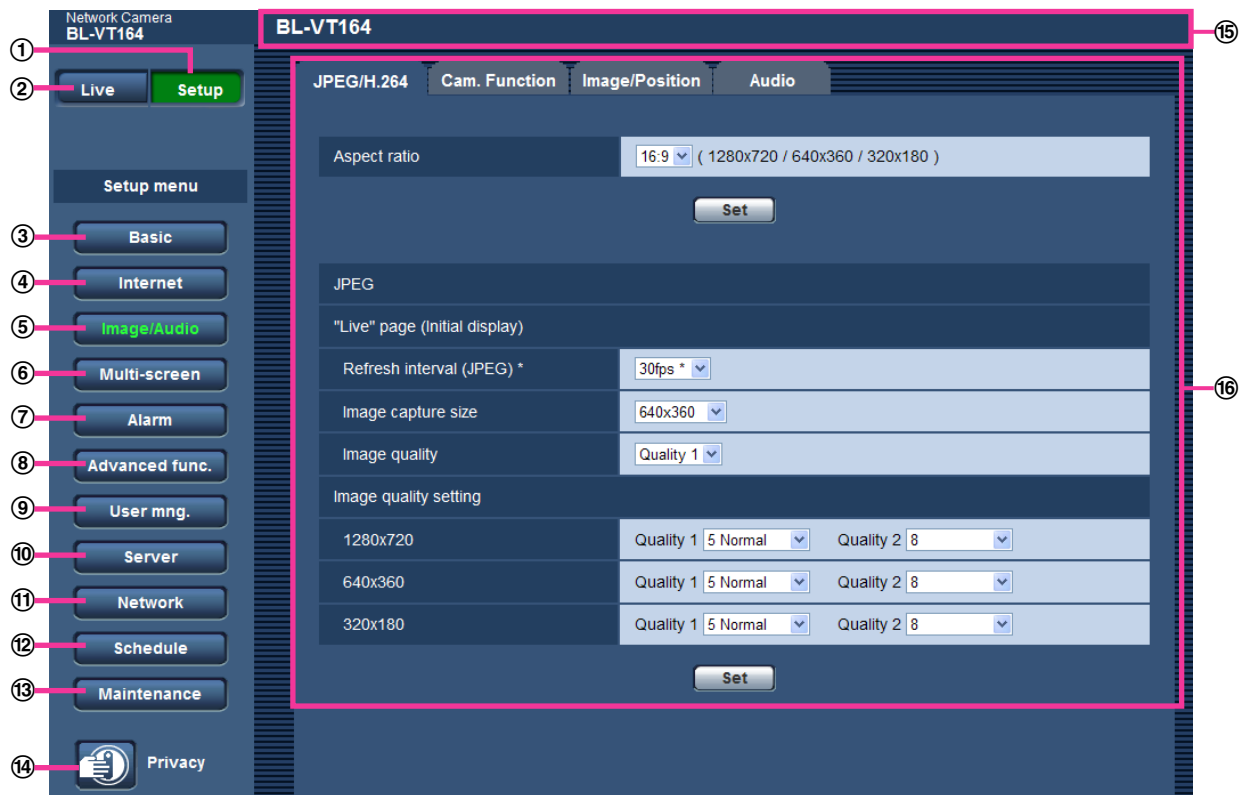

- ① **[Setup] button**
Display the “Setup” page.
- ② **[Live] button**
Display the “Live” page.
- ③ **[Basic] button**
Displays the “Basic” page. The basic settings such as time and date and camera title can be configured on the “Basic” page. (→page 39)
- ④ **[Internet] button**
Displays the “Internet” page. The Internet settings such as UPnP (Auto port forwarding), DDNS (Viewnetcam.com) and the network settings for the Internet can be configured on the “Internet” page. (→page 44)
- ⑤ **[Image/Audio] button** **VT164W** **VT164**
Displays the “Image/Audio” page. The settings relating to image quality, image capture size and camera actions of JPEG/H.264 camera images can be configured on the “Image/Audio” page. (→page 46)
[Image] button **VP104W** **VP104** **VP101**
Displays the “Image” page. The settings relating to image quality, image capture size, etc. of JPEG/H.264 camera images can be configured on the “Image” page. (→page 46)
- ⑥ **[Multi-screen] button**
Displays the “Multi-screen” page. The cameras from which images are to be displayed on a multi-screen can be registered on the “Multi-screen” page. (→page 75)
- ⑦ **[Alarm] button**
Displays the “Alarm” page. The settings relating to alarm occurrences such as settings for the alarm action at an alarm occurrence, the alarm occurrence notification, and the VMD area settings can be configured on the “Alarm” page. (→page 77)

6 Display the setup menu from a PC

- ⑧ **[Advanced func.] button**
Displays the “Advanced func.” page. The setting relating to the XML notification, destinations of information about the face detection and the settings relating to the face detection can be configured on the “Advanced func.” page. (→page 91)
- ⑨ **[User mng.] button**
Displays the “User mng.” page. The settings relating to the authentication such as users and PCs restrictions for accessing the camera can be configured on the “User mng.” page. (→page 94)
- ⑩ **[Server] button**
Displays the “Server” page. The settings relating to the E-mail server, the FTP server and the NTP server to which the camera accesses can be configured on the “Server” page. (→page 99)
- ⑪ **[Network] button**
Displays the “Network” page. The network settings and the settings relating to DDNS (Dynamic DNS), SNMP (Simple Network Management Protocol) and the FTP (File Transfer Protocol) periodic transmission can be configured on the “Network” page. (→page 104)
- ⑫ **[Schedule] button**
Displays the “Schedule” page. On the “Schedule” page, it is possible to designate time zones to allow to receive alarm input or to allow to activate the VMD detection function. (→page 151)
- ⑬ **[Maintenance] button**
Displays the “Maintenance” page. System log check, firmware upgrade, status check and initialization of the setup menu can be carried out on the “Maintenance” page. (→page 154)
- ⑭ **[Privacy] button** **VT164W** **VT164**
Press [Privacy] button to hide the camera images from view temporarily and protect your privacy. (→page 159)
- ⑮ **Camera title**
The title of the camera whose settings are currently being configured will be displayed.
- ⑯ **Setup page**
Pages of each setup menu will be displayed. There are tabs for some setup menus.

7 Configure the basic settings of the camera [Basic]

The basic settings such as camera title, time and date, etc. can be configured on the “Basic” page.
(→page 34, page 35)

The screenshot shows the 'Basic' configuration page with the following settings:

- Camera title:** BL-VT164
- Time & date:**
 - Date/time: Jan / 01 / 2011 00:00:00
 - Time display format: 24h
 - Date/time display format: Mmm/DD/YYYY
 - Summer time (daylight saving): Out
 - NTP/Time zone: NTP >>
 - Start time & date: Mar 2nd Sun 2 AM
 - End time & date: Nov 1st Sun 2 AM
- Camera title on screen:** On Off
- Camera title on screen(0 – 9,A – Z):** [Empty field]
- OSD Position:** Upper left
- Brightness status display:** On Off
- Indicator:** On
- Alarm status update mode:** Polling(30s) Real time
- Alarm status reception port:** 31004 (1-65535)
- Automatic installation of viewer software:** On Off

Buttons: [Set] (under Time & date), [Set] (under Automatic installation of viewer software), [Set] (at the bottom of the page).

[Camera title]

Enter the title of the camera. Click the [Set] button after entering the title of the camera. The entered title will be displayed in the “Camera title” field.

- **Available number of characters:** 0 - 20 characters
- **Unavailable characters:** " &
- **Default:** Varies as follows depending on the model in use.

BL-VT164W (VT164W)/BL-VT164 (VT164)/BL-VP104W (VP104W)/BL-VP104 (VP104)/BL-VP101 (VP101)

[Date/time]

Enter the current time and date. When “12h” is selected for “Time display format”, “AM” or “PM” can be selected.

- **Available range:** 01/01/2010 00:00:00 - 31/12/2035 23:59:59

IMPORTANT

- Depending on the conditions such as the ambient temperature and operating period, the configured time & date may not be accurate.
- Use an NTP server when the more accurate time & date setting is required for the system operation. (→page 101)

[Time display format]

Select the time display format from “24h”, “12h” and “Off”. Enter the current hour reflecting this setting when entering the current time and date for “Date/time”. To hide time and date, select “Off”.

- **Default:** 24h

[Date/time display format]

Select a date/time display format. When “2010/04/01 13:10:00” is set for “Date/time” after selecting “24h” for “Date/time display format”, time & date will be respectively displayed as follows.

- **DD/MM/YYYY:** 01/04/2010 13:10:00
- **MM/DD/YYYY:** 04/01/2010 13:10:00
- **DD/Mmm/YYYY:** 01/Apr/2010 13:10:00
- **YYYY/MM/DD:** 2010/04/01 13:10:00
- **Mmm/DD/YYYY:** Apr/01/2010 13:10:00
- **Default:**
 - DD/MM/YYYY (E/U model)
 - Mmm/DD/YYYY (P model)

[Summer time (daylight saving)]

Select “In”, “Out” or “Auto” to determine whether or not to apply daylight saving time. Configure this setting if the summer time (daylight saving time) is applied in the location where the camera is in use.

- **In:** Applies summer time. An asterisk (*) will be displayed on the left side of the displayed time and date.
- **Out:** Does not apply summer time.
- **Auto:** Applies summer time in accordance with the settings for “Start time & date” and “End time & date” (month, week, day of the week, time).
- **Default:** Out

[NTP/Time zone]

When “NTP >>” is clicked, the [NTP] tab of the “Server” page will be displayed. (→page 101)

[Start time & date] [End time & date]

When “Auto” is selected for “Summer time (daylight saving)”, select the time & date for the start time and the date time (month, week, day of the week, time).

[Camera title on screen]

Select “On” or “Off” to determine whether or not to display the camera title on the screen. When “On” is selected, the character string entered for “Camera title on screen (0-9, A-Z)” will be displayed at the position selected for “OSD”.

- **Default:** Off

Note

- When moving the camera to a preset position, the characters configured for “Camera title on screen” will be deleted, and the preset ID will be displayed instead.

[Camera title on screen (0-9, A-Z)]

Enter a character string to be displayed on the image.

- **Available number of characters:** 0 - 20 characters

- **Available characters:** 0-9, A-Z and the following marks.
! " # \$ % & ' () * + , - . / : ; = ?
- **Default:** None (blank)

[OSD] - [Position]

Select the position where the time and date and a character string to be displayed on the image of the “Live” page.

- **Upper left:** The above information will be displayed at the upper left corner of the main area on the “Live” page.
- **Lower left:** The above information will be displayed at the lower left corner of the main area on the “Live” page.
- **Upper right:** The above information will be displayed at the upper right corner of the main area on the “Live” page.
- **Lower right:** The above information will be displayed at the lower right corner of the main area on the “Live” page.
- **Default:** Upper left

[Brightness status display]

Select “On” or “Off” to determine whether or not to display the status of brightness on images displayed on the “Live” page when adjusting brightness.

- **Default:** On

[Indicator]

Determine whether or not to use the following indicators.

- POWER indicator
 - **On:** The indicator will light in accordance with the status.
 - **On(Access):** The indicator will light when images are viewed.
 - **On(With body heat sensor) (VT164W) (VT164):** The indicator lights for 1 second when the body heat sensor (pyroelectric infrared sensor) is triggered (when a detection is made).
 - **Off:** The indicator will light off.
 - **Default:** On
- WIRELESS indicator (WPS indicator) (VT164W) (VP104W)
 - **On:** The indicator will light in accordance with the WPS operation status.
 - **On(Access):** The indicator will light during start up for the WPS and light off during normal use.
 - **Off:** The indicator will light during start up for the WPS and light off during normal use.
 - **Default:** On

Note

- **POWER indicator (Red/Orange/Green):** The indicator will light or blink as follows depending on the camera status.

Operation status		Indicator status
When the power is turned on	Before the network connection is established	Blinks orange
	When the network connection is established	Blinks orange → Blinks green → Lights green
During standby or connection (Cable is not connected.)		Lights orange
During standby or connection (Cable is connected.)		Lights green
During the upgrade process		Blinks orange

7 Configure the basic settings of the camera [Basic]

Operation status	Indicator status
During the initialization	Blinks orange → Lights off
Port forwarding error caused by the UPnP function	Blinks orange (in 2 seconds intervals (on for 1 second / off for 1 second))
Trouble happening on the camera	Blinks red
When there is a body heat sensor detection (VT164W) (VT164)	Lights orange (for 1 second)
During privacy mode	Lights red

- **WIRELESS indicator (Red/Orange/Green) (VT164W) (VP104W)**: The WIRELESS indicator will light or blink as follows depending on the wireless status.

Operation status	Indicator status
WPS is not configured	Lights off
WPS is starting up	Blinks orange
WPS settings succeeded (WPS defined)	Lights green
WPS settings failed	Blinks red for about 10 seconds → Lights off

[Alarm status update mode]

Select an interval of the camera status notification from the following.

When the status of the camera changes, the alarm occurrence indication button, the [AUX] button will be displayed to notify of the camera status.

- **Polling(30s)**: Updates the status each 30 seconds and provide notification of the camera status.
- **Real time**: Provide notification of the camera status when the status has changed.
- **Default**: Polling(30s)

Note

- Depending on the network environment, notification may not be provided in real time.

[Alarm status reception port]

When selecting “Real time” for “Alarm status update mode”, designate a port number to which the status change notification is to be sent.

- **Available port number**: 1 - 65535
- **Default**: 31004

The following port numbers are unavailable since they are already in use.

20, 21, 23, 25, 42, 53, 67, 68, 69, 80, 110, 123, 161, 162, 443, 995, 10669, 10670

[Automatic installation of viewer software]

Determine whether or not to install the viewer software from this camera.

- **On**: Installs the viewer software from the camera automatically.
- **Off**: The viewer software cannot be installed from the camera.
- **Default**: On

IMPORTANT

- It is impossible to display images and to receive/transmit audio between the camera and the PC when the viewer software “Network Camera View 4S” is not installed on the PC.
- The number of the viewer software installations can be checked on the [Upgrade] tab of the “Maintenance” page.

[Language]

Select the language to initially display when the camera is accessed from the following.
English/Japanese/Italian/French/German/Spanish/Chinese/Russian

- **Default:** English

The language displayed on the “Live” page can also be changed. (→ **VT164W** **VT164**: page 10, **VP104W**

VP104 **VP101**: page 15)

8 Configure the Internet settings [Internet]

The settings for connecting the camera to the Internet can be configured on the “Internet” page. (→page 34, page 35)

The settings relating to UPnP (Auto port forwarding), DDNS (Viewnetcam.com), and network settings for the Internet can be configured on this page.

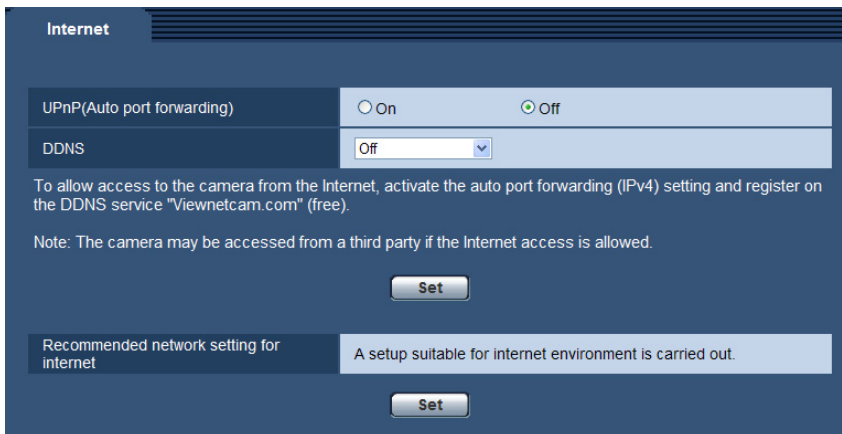

[UPnP (Auto port forwarding)]

Select “On” or “Off” to determine whether or not to use the port forwarding function of the router.

To use the auto port forwarding function, the router in use must support UPnP and the UPnP must be enabled.

- **Default:** Off

Note

- Due to auto port forwarding, the port number may sometimes be changed. When the number is changed, it is necessary to change the port numbers registered in the PC and recorders, etc.
- The UPnP function is available when the camera is connected to the IPv4 network. IPv6 is not supported.
- To check if auto port forwarding is properly configured, click the [Status] tab on the “Maintenance” page, and check that the “Enable” is displayed for “Status” of “UPnP”. (→page 156)
When “Enable” is not displayed, refer to “Cannot access the camera via the Internet.” in 22 Troubleshooting.
- When the “UPnP (Auto port forwarding)” setting is changed, the “Auto port forwarding” setting under “UPnP” on the [Network] tab of the “Network” page also changes to the same setting.

[DDNS]

Select “Off” or “Viewnetcam.com” to determine whether or not to use “Viewnetcam.com”.

By selecting “Viewnetcam.com” and clicking the [Set] button, the registration window for “Viewnetcam.com” will be displayed in a newly opened window.

Follow the on-screen instructions to register with “Viewnetcam.com”.

Refer to the “Viewnetcam.com” website (<http://www.viewnetcam.com/>) for further information about the service.

- **Default:** Off

Note

- When the “DDNS” setting is changed, the “DDNS” setting on the [DDNS] tab of the “Network” page also changes to the same setting.

[Recommended network setting for internet]

The recommended settings for connecting to the Internet are performed here.

By clicking the [Set] button, a dialog displaying how the following settings will change is displayed.

Click the [OK] button after checking the settings to change the settings to the displayed values.

- [JPEG/H.264] tab on the “Image/Audio” page
 - [H.264(1)]/[H.264(2)]
 - [Internet mode (over HTTP)]: On
 - [Transmission priority]: Best effort
- [Network] tab on the “Network” page
 - [Common]
 - [Max RTP packet size]: Limited(1280byte)
 - [HTTP max segment size(MSS)]: Limited(1280byte)

9 Configure the settings relating to images and audio [Image/Audio] (BL-VT164W/BL-VT164)/ Configure the settings relating to images [Image] (BL-VP104W/BL-VP104/BL-VP101)

VT164W **VT164**:

The settings relating to JPEG and H.264 images such as the settings of image quality, audio, etc. can be configured on this page.

The “Image/Audio” page has 4 tabs; the [JPEG/H.264] tab, the [Cam. Function] tab, the [Image/Position] tab and the [Audio] tab.

VP104W **VP104** **VP101**:

The settings relating to JPEG and H.264 images such as the settings of image quality, etc. can be configured on this page.

The “Image” page has 2 tabs; the [JPEG/H.264] tab and the [Image/Privacy] tab.

9.1 Configure the settings relating to the aspect ratio [JPEG/H.264]

Click the [JPEG/H.264] tab on the “Image/Audio” page. (→page 34, page 35)



[Aspect ratio]

Select the aspect ratio.

- 4:3
- 16:9
- **Default:** 16:9 **VT164W** **VT164** **VP104W** **VP104** /4:3 **VP101**

Note

VT164W **VT164** **VP104W** **VP104**:

- Image adjustment functions are activated for the angle of view in the aspect ratio of 16:9 even while “4:3” is being selected for “Aspect ratio”. When setting the mask area for the back light compensation (BLC) function, it is recommended to configure the setting after selecting “16:9” for “Aspect ratio”.

VP101:

- Image adjustment functions are activated for the angle of view in the aspect ratio of 4:3 even while “16:9” is being selected for “Aspect ratio”. When setting the mask area for the back light compensation (BLC) function, it is recommended to configure the setting after selecting “4:3” for “Aspect ratio”.

9.2 Configure the settings relating to JPEG images [JPEG/H.264]

Click the [JPEG/H.264] tab on the “Image/Audio” page. (→page 34, page 35)

JPEG	
"Live" page (Initial display)	
Refresh interval (JPEG) *	30fps *
Image capture size	640x360
Image quality	Quality 1
Image quality setting	
1280x720	Quality 1 5 Normal Quality 2 8
640x360	Quality 1 5 Normal Quality 2 8
320x180	Quality 1 5 Normal Quality 2 8
Set	

JPEG

Configure the settings such as “Refresh interval (JPEG)*”, “Image capture size” and “Image quality” on this section. Refer to page 49 for further information about the settings relating to H.264 images.

"Live" page (Initial display)

Configure the settings relating to the JPEG images displayed on the “Live” page.

[Refresh interval (JPEG)*]

Select an interval to refresh the displayed JPEG image from the following.

0.1fps/ 0.2fps/ 0.33fps/ 0.5fps/ 1fps/ 2fps/ 3fps/ 5fps/ 6fps*/ 10fps*/ 12fps*/ 15fps*/ 30fps*

- **Default:** 30fps*

Note

- When “H.264 transmission” is operating, the refresh interval may be longer than the set value when any value with an asterisk (*) on the right is selected.
- Depending on factors such as the network environment, the resolution, the image quality, or the number of computers concurrently accessing the camera, the transmission interval may be longer than the set value.
- If images are not delivered in the specified transmission interval, you can make the images be delivered closer to the specified time by lowering the resolution or image quality.

[Image capture size]

Select the image capture size to display the JPEG image on the “Live” page for the first time.

When “4:3” is selected for “Aspect ratio”

VT164W **VT164** **VP104W** **VP104** :

QVGA/ VGA/ 800x600

VP101 :

QVGA/ VGA

When “16:9” is selected for “Aspect ratio”

VT164W **VT164** **VP104W** **VP104** :

320x180/ 640x360/ 1280x720

9 Configure the settings relating to images and audio [Image/Audio] (BL-VT164W/BL-VT164)/ Configure the settings relating to images [Image] (BL-VP104W/BL-VP104/BL-VP101)

VP101:

320x180/ 640x360

- **Default:** 640x360 **VT164W** **VT164** **VP104W** **VP104** /VGA **VP101**

[Image quality]

Select the image quality of JPEG images displayed initially on the “Live” page.

- **Default:** Quality1

[Image quality setting]

Select two types of image quality of JPEG images for each image capture size.

0 Super fine/ 1 Fine/ 2/ 3/ 4/ 5 Normal/ 6/ 7/ 8/ 9 Low

- **Default:**
 - Quality1: 5 Normal
 - Quality2: 8

The setting for “Quality1” is activated for FTP periodic image transmission, files attached to alarm E-mails.

9.3 Configure the settings relating to H.264 images [JPEG/H.264]

Click the [JPEG/H.264] tab on the “Image/Audio” page. (→page 34, page 35)

9 Configure the settings relating to images and audio [Image/Audio] (BL-VT164W/BL-VT164)/ Configure the settings relating to images [Image] (BL-VP104W/BL-VP104/BL-VP101)

Configure the settings relating to H.264 image such as “Max bit rate (per client)”, “Image capture size”, “Image quality”, etc. in this section. Refer to page 47 for the settings relating to JPEG images.

H.264(1)	
H.264 transmission	<input checked="" type="radio"/> On <input type="radio"/> Off
Internet mode (over HTTP)	<input checked="" type="radio"/> On <input type="radio"/> Off
Image capture size	640x360
Transmission priority	Best effort
Frame rate*	30fps
Max bit rate (per client) *	Max 1024kbps - Min 128kbps
Image quality	Normal
Refresh interval	1s
Transmission type	Unicast port (AUTO)
Unicast port1(Image)	32004 (1024-50000)
Unicast port2(Audio)	33004 (1024-50000)
Multicast address	239.192.0.20
Multicast port	37004 (1024-50000)
Multicast TTL/HOPLimit	16 (1-254)
<input type="button" value="Set"/>	
H.264(2)	
H.264 transmission	<input checked="" type="radio"/> On <input type="radio"/> Off
Internet mode (over HTTP)	<input checked="" type="radio"/> On <input type="radio"/> Off
Image capture size	320x180
Transmission priority	Best effort
Frame rate*	30fps
Max bit rate (per client) *	Max 1024kbps - Min 128kbps
Image quality	Normal
Refresh interval	1s
Transmission type	Unicast port (AUTO)
Unicast port1(Image)	32014 (1024-50000)
Unicast port2(Audio)	33014 (1024-50000)
Multicast address	239.192.0.21
Multicast port	37004 (1024-50000)
Multicast TTL/HOPLimit	16 (1-254)
<input type="button" value="Set"/>	
Smoother live video display on the browser (buffering)	<input type="radio"/> On <input checked="" type="radio"/> Off
<input type="button" value="Set"/>	

H.264(1)/H.264(2)

[H.264 transmission]

Select “On” or “Off” to determine whether or not to transmit H.264 images.

- **On:** Transmits H.264 images.
- **Off:** Does not transmit H.264 images.
- **Default:** On

Note

- When “On” is selected for “H.264 transmission” in “H.264(1)” or “H.264(2)”, displaying of H.264 images or JPEG images on the “Live” page will become available.
- When “On” is selected for “H.264 transmission” in “H.264(1)” and “H.264(2)”, H.264 images are viewable using other devices with each setting.
- When “On” is selected for “H.264 transmission” in “H.264(1)” or “H.264(2)”, the transmission interval of JPEG images may sometimes become longer.

[Internet mode (over HTTP)]

Select “On” when transmitting H.264 images via the Internet. It is possible to transmit H.264 images without changing the broadband router settings configured for JPEG image transmission.

- **On:** H.264 images and audio will be transmitted using the HTTP port. Refer to page 107 for further information about the HTTP port number settings.
- **Off:** H.264 images and audio will be transmitted using the UDP port.
- **Default:** On

Note

- When “On” is selected, only “Unicast port (AUTO)” will be available for “Transmission type”.
- When “On” is selected, it may take time to start displaying H.264 images.
- When “On” is selected, H.264 images may not be displayed depending on the number of the concurrent access user and audio data availability, etc.
- When “On” is selected, only IPv4 access is available.

[Image capture size]

Select the image capture size from the following.

When “4:3” is selected for “Aspect ratio”

VT164W **VT164** **VP104W** **VP104** :

- H.264(1): QVGA/ VGA/ 800x600
- H.264(2): QVGA/ VGA

VP101 :

QVGA/ VGA

When “16:9” is selected for “Aspect ratio”

VT164W **VT164** **VP104W** **VP104** :

- H.264(1): 320x180/ 640x360/ 1280x720
- H.264(2): 320x180/ 640x360

VP101 :

320x180/ 640x360

- **Default:**

VT164W **VT164** **VP104W** **VP104** :

- H.264(1): 640x360
- H.264(2): 320x180

VP101 :

- H.264(1): VGA
- H.264(2): QVGA

[Transmission priority]

Select a transmission priority for H.264 images from the following.

- **Constant bit rate:** H.264 images will be transmitted with the bit rate selected for “Max bit rate (per client)*”.
- **Frame rate:** H.264 images will be transmitted with the frame rate selected for “Frame rate*”.
- **Best effort:** In accordance with the network bandwidth, H.264 images will be transmitted with the bit rate varying between the maximum and minimum bit rates that are set for “Max bit rate (per client)*”.
- **Default:** Best effort

Note

- When “Frame rate” is selected for “Transmission priority”, number of users who can access the camera may be limited more (may become less than 10).

[Frame rate*]

Select a frame rate for H.264 images from the following.

1fps/ 3fps/ 5fps*/ 7.5fps*/ 10fps*/ 12fps*/ 15fps*/ 20fps*/ 30fps*

- **Default:** 30fps*

Note

- When “Frame rate” is selected for “Transmission priority”, this setting is available.
- “Frame rate*” is limited by “Max bit rate”. For this reason, the frame rate may be lower than the specified value when any value marked with an asterisk (*) is selected.

[Max bit rate (per client)*]

Select a H.264 bit rate per a client from the following. When “Best effort” is selected for “Transmission priority”, set the maximum and minimum bit rates. When “Constant bit rate” or “Frame rate” is selected in “Transmission priority”, only the maximum bit rate can be set.

64kbps/ 128kbps*/ 256kbps*/ 384kbps*/ 512kbps*/ 768kbps*/ 1024kbps*/ 1536kbps*/ 2048kbps*/ 3072kbps*/ 4096kbps*/ 8192kbps* */ Unlimited*

- **Default:** Max 1024kbps* - Min 128kbps*

As in the following, the range of bit rates that can be configured for the H.264 bit rates differs depending on the “Image capture size”.

- 1280x720: 8192kbps*¹ - 256kbps
- 800x600¹: 4096kbps - 128kbps
- VGA, QVGA, 640x360, 320x180: 4096kbps - 64kbps

“Unlimited*” is available only when “Frame rate” is selected for “Transmission priority”.

Note

- When “8192kbps*” or “Unlimited*” is selected, the number of users who can access H.264 images will be limited to “1”. (Only a single user can access H.264 images.)
- The H.264 bit rate is limited by “Bandwidth control(bit rate)” on the [Network] tab of “Network” page (→page 104). For this reason, the bit rate may be lower than the value when any value with an asterisk (*) on the right is selected.
- It is impossible to select “Unlimited*” for both “H.264(1)” and “H.264(2)”.

[Image quality]

Select the image quality of H.264 images from the following.

Low(Motion priority)/ Normal/ Fine(Image quality priority)

- **Default:** Normal

Note

- When “Constant bit rate” or “Best effort” is selected for “Transmission priority”, this setting is available.

[Refresh interval]

Select an interval (I-frame interval; 0.2 - 5 seconds) to refresh the displayed H.264 images.

If using under a network environment with frequent error occurrences, shorten the refresh interval for H.264 to diminish image distortions. However, the refresh interval may be longer than the set value.

0.2s/ 0.25s/ 0.33s/ 0.5s/ 1s/ 2s/ 3s/ 4s/ 5s

- **Default:** 1s

[Transmission type]

Select the transmission type of H.264 images from the following.

- **Unicast port (AUTO):** Up to 14 users can access a single camera concurrently. "Unicast port1(Image)" and "Unicast port2(Audio)" will automatically be selected when transmitting images and audio from the camera. When it is unnecessary to fix the port number for H.264 image transmission such as when using in a particular LAN environment, it is recommended to select "Unicast port (AUTO)".
- **Unicast port (MANUAL):** Up to 14 users can access a single camera concurrently. It is necessary to select "Unicast port1(Image)" and "Unicast port2(Audio)" manually to transmit images and audio from the camera. It is possible to fix the port number of the router used for H.264 image transmission via the Internet by setting "Unicast port (MANUAL)" (→page 104). Refer to the operating instructions of the router in use.
- **Multicast:** Unlimited number of users can access a single camera concurrently. Complete the entry field of "Multicast address", "Multicast port" and "Multicast TTL/HOPLimit" when transmitting H.264 images with multicast.
* Refer to page 7 for further information about the maximum concurrent access number.
- **Default:** Unicast port (AUTO)

[Unicast port1(Image)]²

Enter the unicast port number (used to transmit images from the camera).

- **Available port number:** 1024 - 50000 (Only even numbers are available.)
- **Default:**
 - H.264(1): 32004
 - H.264(2): 32014

[Unicast port2(Audio)]²

Enter the unicast port number (used to transmit audio from the camera).

- **Available port number:** 1024 - 50000 (Only even numbers are available.)
- **Default:**
 - H.264(1): 33004
 - H.264(2): 33014

[Multicast address]³

Enter the multicast IP address. Images and audio will be transmitted to the designated IP address.

- **Available IPv4 address:** 224.0.0.0 - 239.255.255.255
- **Available IPv6 address:** Multicast address starting with "FF"
- **Default:**
 - H.264(1): 239.192.0.20
 - H.264(2): 239.192.0.21

Note

- Enter a multicast IP address after checking available multicast address.

[Multicast port]³

Enter the multicast port number (used to transmit images from the camera).

- **Available port number:** 1024 - 50000 (Only even numbers are available.)
- **Default:** 37004

9 Configure the settings relating to images and audio [Image/Audio] (BL-VT164W/BL-VT164)/ Configure the settings relating to images [Image] (BL-VP104W/BL-VP104/BL-VP101)

Note

- When audio is transmitted from the unit, the port number to be used will be the multicast port number plus "1000".

[Multicast TTL/HOPLimit]³

Enter a value for "Multicast TTL/HOPLimit".

- **Available value:** 1-254
- **Default:** 16

IMPORTANT

- When transmitting an H.264 image via a network, the transmitted image sometimes may not be displayed depending on the settings of a proxy server or a firewall. In this case, refer to the network administrator.
- When two or more network interface cards are installed on the PC in use, the network interface card(s) not used for receiving images should be invalidated when displaying images using the multicast port.

[Smoother live video display on the browser (buffering)]

Perform settings to display camera images on the viewer software.

- **On:** Images are temporarily stored on the computer and are displayed smoother.
- **Off:** Images are displayed in real-time and are not stored on the computer.
- **Default:** Off

¹ **VT164W** **VT164** **VP104W** **VP104**

² It is necessary to designate the unicast port number when "Unicast port (MANUAL)" is selected for "Transmission type".

³ It is necessary to designate the multicast IP address when "Multicast" is selected for "Transmission type".

9.4 Configure the settings relating to the camera operations [Cam. Function] (BL-VT164W/BL-VT164)

Click the [Cam. Function] tab on the “Image/Audio” page. (→page 34, page 35)
Configure the settings relating to camera operations.

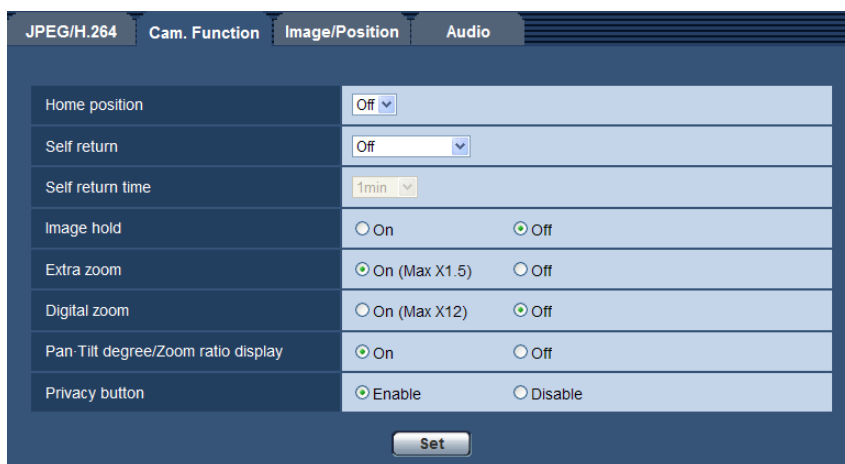

[Home position]

A preset position (→page 65) can be set as the home position.

When a preset position is set as the home position, “H” will be displayed next to the preset position number.

- **Default:** Off

Note

- To move the camera to the home position when the power of the camera is turned on, select “Home position” for “Self return”.

[Self return]

When the time set for “Self return time” has passed after manual operations of the camera, the camera will automatically be in the selected mode.

- **Off:** Self return is not performed.
- **Home position:** When the set time has passed, the camera will move to the home position automatically.
- **Default:** Off

Note

- This function is also useful to automatically set the camera in a specific mode when the power of the camera is turned on.
- The self return function works even when the setup menu is displayed.

[Self return time]

Select a waiting time (amount of time until the camera starts the selected operation after the end of the manual operations) from the following.

10s/ 20s/ 30s/ 1min/ 2min/ 3min/ 5min/ 10min/ 20min/ 30min/ 60min

- **Default:** 1min

[Image hold]

Select “On” or “Off” to determine whether or not to hold the still image on the screen (that is displayed at the last moment before the camera started to move to a preset position) until the camera has moved to the preset position.

9 Configure the settings relating to images and audio [Image/Audio] (BL-VT164W/BL-VT164)/ Configure the settings relating to images [Image] (BL-VP104W/BL-VP104/BL-VP101)

- **On:** A still image will be held on the screen until the camera has moved to the preset position.
- **Off:** Images from the camera will be displayed even when the camera is moving to the preset position.
- **Default:** Off

[Extra zoom]

Select the extra zoom setting from the following.

- **On (Max X1.5):** Images can be zoomed in on with the extra zoom (1x - 1.5x).
- **Off:** Does not use the extra zoom.
- **Default:** On (Max X1.5)

About extra zoom

Among approx. 1.0 megapixel image capture area of the CMOS image sensor, the central part of approx. 0.31 megapixels is extracted for shooting. That enables the shooting with a higher zooming effect. When the image capture size at "VGA" is applied, the zoom factor can be adjusted up to 1.5x.

[Digital zoom]

Select the digital zoom setting from the following.

- **On (Max X12):** Images can be zoomed in on with the extra zoom (1x - 1.5x) and the electronic zoom (higher zoom factors, up to 12x).
- **Off:** Does not use the digital zoom.
- **Default:** Off

Note

- When the zoom factor is 1.5x or more, the setting of the preset positions will become unavailable.

[Pan-Tilt degree/Zoom ratio display]

Select "On" or "Off" to determine whether or not to display the current panning/tilting degree and the zoom ratio display on images when the camera is being operated manually.

- **On:** Displays the current panning/tilting degree and the zoom ratio display.
- **Off:** Does not display the current panning/tilting degree and the zoom ratio display.
- **Default:** On

Note

- When "On" is selected, the panning/tilting degree and the zoom factor will be displayed at the position selected for "OSD" on the "Basic" page. (→page 41)

[Privacy button]

Select the privacy button setting from the following.

- **Enable:** Activates the privacy button function.
- **Disable:** Deactivates the privacy button function.
- **Default:** Enable

9.5 Configure the settings relating to images and the preset positions [Image/Position] (BL-VT164W/BL-VT164)/ Configure the settings relating to image adjust, extra zoom, and privacy zone [Image/Privacy] (BL-VP104W/BL-VP104/BL-VP101)

VT164W **VT164** :

Click the [Image/Position] tab on the “Image/Audio” page. (→page 34, page 35)

When the [Setup>>] button of each setting item is clicked, the detailed settings menu will be displayed in a newly opened window. The detailed settings can be configured while monitoring images displayed on the [Image/Position] tab.

The settings relating to image quality, preset positions, and privacy zone can be configured in this section.

VP104W **VP104** **VP101** :

Click the [Image/Privacy] tab on the “Image” page. (→page 34, page 35)

When the [Setup>>] button of each setting item is clicked, the detailed settings menu will be displayed in a newly opened window. The detailed settings can be configured while monitoring images displayed on the [Image/Privacy] tab.

The settings relating to image adjust, extra zoom and privacy zone can be configured in this section.

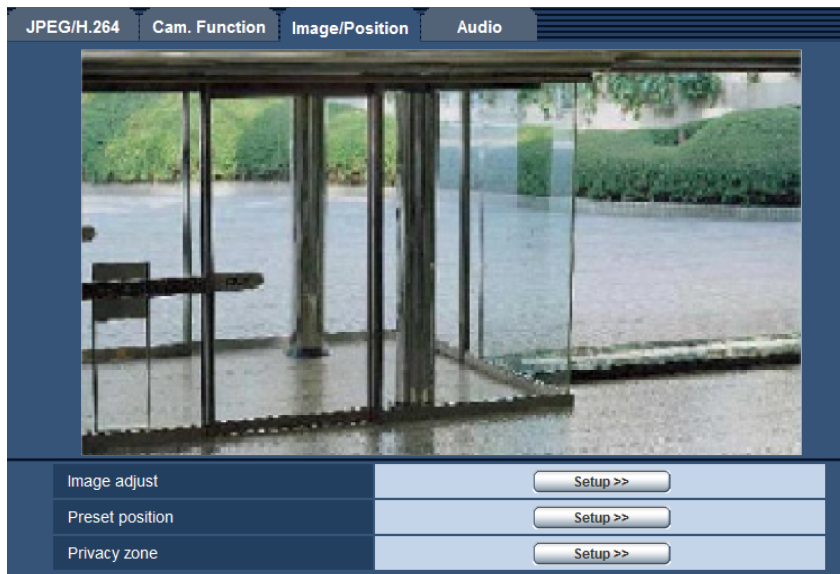

[Image adjust]

Click the [Setup>>] button to display the setup menu that can configure the settings relating to image quality. The setup menu will be displayed in a newly opened window. (→page 58)

[Preset position] **VT164W** **VT164**

Click the [Setup>>] button to display the setup menu that can configure the settings relating to the preset positions. The setup menu will be displayed in a newly opened window. (→page 65)

[Extra zoom] **VP104W** **VP104**

Click the [Setup>>] button to display the setup menu that can configure the settings relating to extra zoom. The setup menu will be displayed in a newly opened window. (→page 68)

[Privacy zone]

Click the [Setup>>] button to display the setup menu that can configure the settings relating to the privacy zone. The setup menu will be displayed in a newly opened window. (→page 68, page 70)

9.5.1 Configure the settings relating to image quality (“Image adjust” setup menu)

VT164W **VT164**:

Click the [Setup>>] button of “Image adjust” on the [Image/Position] tab of the “Image/Audio” page. (→page 57) The settings relating to image quality can be configured with the setup menu displayed in a newly displayed window. When the values are changed, the changed values will be applied to the currently displayed image on the [Image/Position] tab.

VP104W **VP104** **VP101**:

Click the [Setup>>] button of “Image adjust” on the [Image/Privacy] tab of the “Image” page. (→page 57) The settings relating to image quality can be configured with the setup menu displayed in a newly displayed window. When the values are changed, the changed values will be applied to the currently displayed image on the [Image/Privacy] tab.

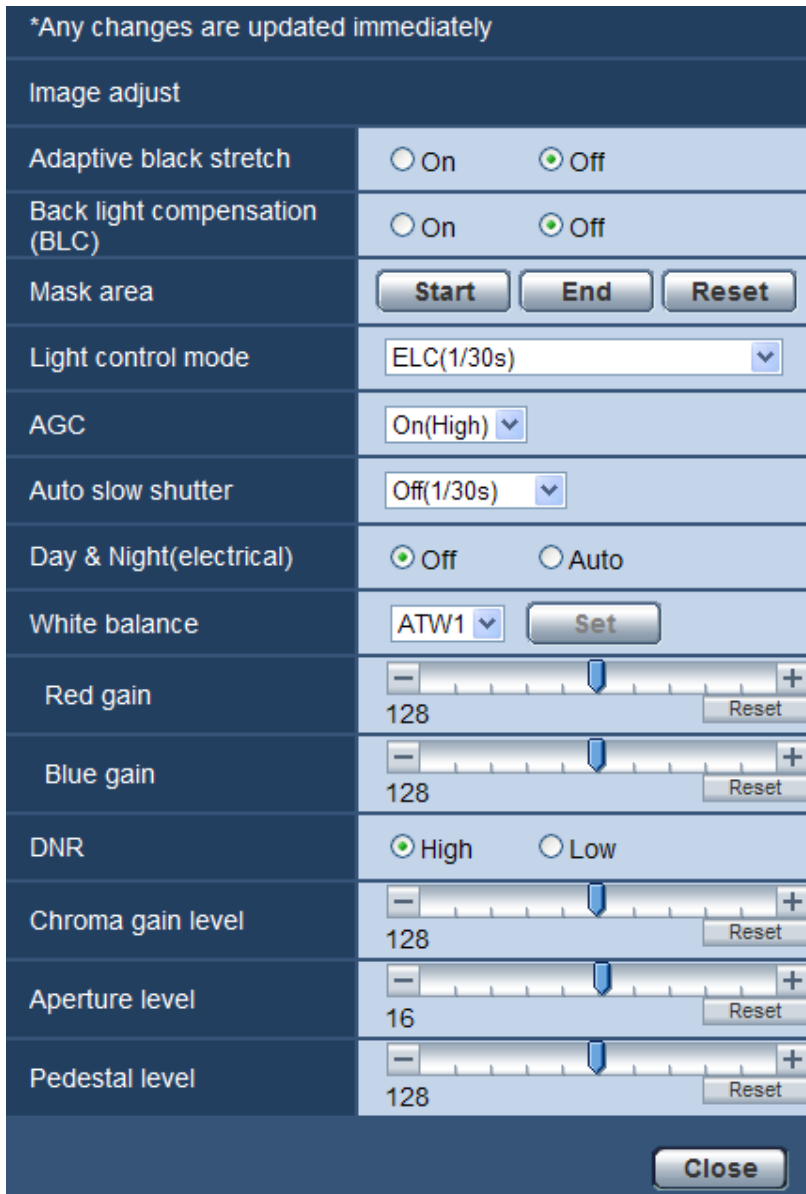

[Adaptive black stretch]

Select “On” or “Off” to determine whether or not to activate the darkness compensation function. The darkness compensation function can make darker parts of images brighter by digital image processing.

- **On:** Activates the darkness compensation function.
- **Off:** Deactivates the darkness compensation function.
- **Default:** Off

IMPORTANT

- When “On” is selected for “Adaptive black stretch”, noise in the darker parts may be increased, and parts around borders between the darker parts and the brighter parts may become darker/brighter than the other darker/brighter parts.

[Back light compensation (BLC)]

Select “On” or “Off” to determine whether or not to activate the back light compensation (BLC) function. The back light compensation function can compensate back light by setting mask areas on brighter parts of images.

- **On:** Mask areas will be set automatically.
- **Off:** Mask areas will not be set automatically. It is necessary to set them manually.
- **Default:** Off

[Mask area]

When “Off” is selected for “Back light compensation (BLC)”, it is possible to compensate for back light by masking brighter areas.

Refer to page 62 for information on how to set the mask area.

[Light control mode]

Select the light control mode from the following.

- **Indoor scene (50 Hz) / Indoor scene (60 Hz):** The shutter speed will automatically be adjusted to prevent flicker caused by fluorescent light. Select 50 Hz or 60 Hz corresponding to the location where the camera is in use.
- **ELC(Maximum exposure time):** The lighting control will be automatically performed by adjusting shutter speed in the range of ELC.
 (VT164W) (VT164) (VP104W) (VP104) :
 ELC(1/30s)/ ELC(3/100s)/ ELC(3/120s)/ ELC(2/100s)/ ELC(2/120s)/ ELC(1/100s)/ ELC(1/120s)/
 ELC(1/250s)/ ELC(1/500s)/ ELC(1/1000s)/ ELC(1/2000s)/ ELC(1/4000s)/ ELC(1/10000s)
 (VP101) :
 ELC(1/30s)/ ELC(3/100s)/ ELC(3/120s)/ ELC(2/100s)/ ELC(2/120s)/ ELC(1/100s)/ ELC(1/120s)/
 ELC(1/250s)/ ELC(1/500s)/ ELC(1/1000s)/ ELC(1/2000s)/ ELC(1/4000s)/ ELC(1/8000s)
- **Default:** ELC(1/30s)

Note

- The shorter the maximum exposure time is, the more accurately it is possible to capture a fast moving object with less blur.
- When a faster shutter speed is selected, the sensitivity will become lower.
- When a faster shutter speed is selected, flickering may happen.
In case flickering happens, it may be improved by configuring the following settings.
In the area of 50 Hz power supply frequency:
– ELC(3/100s), ELC(2/100s), ELC(1/100s)
In the area of 60 Hz power supply frequency:
– ELC(3/120s), ELC(2/120s), ELC(1/120s)
When flickering still remains, set flicker-less mode.
- Under extremely strong lighting, flickering may happen even when “Indoor scene” is selected for “Light control mode”.
When the brightness (illuminance) level on the screen is set to a relatively low level with the [Brightness] buttons, flickering may frequently happen.
- When the setting for “Light control mode” is “Indoor scene (50 Hz)”, “Indoor scene (60 Hz)” or “ELC” whose maximum exposure time is 1/2000s or longer, brightness may not be remarkably changed even when [Brightness] buttons are clicked.

[AGC]

Select a method of gain adjustment from the following.

- **On(High)/On(Mid)/On(Low):** When the luminance of the subject becomes darker, gain will be automatically incremented and screen will become brighter. “High”, “Mid” and “Low” are indications of gain level.

- **Off:** Images will be captured with the fixed gain level.
- **Default:** On(High)

[Auto slow shutter]

The electronic sensitivity enhancement (sensitivity up) can be carried out by adjusting the storage time of the sensor.

The following are available for the recording duration.

VT164W **VT164** **VP104W** **VP104** :

Off(1/30s), Max.2/30s, Max.4/30s, Max.6/30s, Max.10/30s, Max.16/30s

VP101 :

Off(1/30s), Max.2/30s, Max.3/30s, Max.4/30s, Max.8/30s

- **Default:** Off(1/30s)

IMPORTANT

- When “On” is selected for “Auto slow shutter”, frame rate may become lower. Noise or white dots (blemishes) may sometimes appear.

Note

- When “Max. 16/30s” **VT164W** **VT164** **VP104W** **VP104** / “Max.8/30s” **VP101** is selected, for example, sensitivity will automatically be increased up to x16. When “Off” is selected for “AGC”, this setting is unavailable.

[Day & Night(electrical)]

Select switching between the color mode and the black & white mode from the following.

- **Off:** The color mode is selected.
- **Auto:** Switches from color to black-and-white images when the ambient brightness (illuminance) of the camera is approx. 1.0 lx or less. It takes time to switch between modes.
- **Default:** Off

[White balance]

Select a method of white balance adjustment from the following.

White color can be adjusted by “Red gain” and “Blue gain”.

- **ATW1:** Selects the automatic tracing white balance mode. The camera will constantly check the color temperature of the light source and adjust the white balance automatically. Operating color temperature range is approx. 2,700 K - 6,000 K.
- **ATW2:** Selects the automatic tracing white balance mode under a sodium lamp. The camera will adjust the white balance automatically under a sodium lamp. Operating color temperature range is approx. 2,000 K - 6,000 K.
- **AWC:** Selects the automatic white balance control mode. This adjustment is suitable for a location where a light source is stable. Operating color temperature range is approx. 2,000 K - 10,000 K.
- **Default:** ATW1

Note

- Under the following conditions, color may not be faithfully processed. In these cases, select “AWC”.
 - When shooting a subject whose major part is a thick color
 - When shooting blue sky or sun at sunset
 - When shooting a subject whose luminance is too low
- When “AWC” is selected, click the [Set] button.

[Red gain]

Adjust the red color of images.

When the cursor is moved in the “+” direction, the red color will become thicker.

When the cursor is moved in the “-” direction, the red color will be thinner.

Click the [Reset] button to reset the color to the default.

- **Default:** 128

[Blue gain]

Adjust the blue color of images.

When the cursor is moved in the “+” direction, the blue color will become thicker.

When the cursor is moved in the “-” direction, the blue color will be thinner.

Click the [Reset] button to reset the color to the default.

- **Default:** 128

[DNR]

The digital noise reduction function reduces noise automatically under the condition of low illuminance. Select an effect level “High” or “Low” for the digital noise reduction.

- **High:** High DNR, afterimage remains
- **Low:** Low DNR, reduces afterimage
- **Default:** High

[Chroma gain level]

Adjusts the chroma level (color density).

When the cursor is moved in the “+” direction, the colors will become thicker. When the cursor is moved in the “-” direction, the colors will be thinner. Click the [Reset] button to reset the color to the default.

- **Default:** 128

[Aperture level]

Adjust the aperture level (outline compensation).

Images will be sharper when the cursor is moved in the “+” direction, and will be softer when the cursor is moved in the “-” direction.

Click the [Reset] button to reset the color to the default.

- **Default:** 16

[Pedestal level]

Adjust the black level of images by moving the cursor. When the cursor is moved to the “+” direction, images will become brighter. When the cursor is moved to the “-” direction, images will be darker. Click the [Reset] button to reset the color to the default.

- **Default:** 128

[Close] button

Click this button to quit the “Image adjust” setup menu.

9.5.2 Set mask areas

When “Off” is selected for “Back light compensation (BLC)”, it is possible to compensate for back light by masking brighter areas.

1. Display the “Image adjust” setup menu. (→page 57)

*Any changes are updated immediately

Image adjust

Adaptive black stretch	<input type="radio"/> On <input checked="" type="radio"/> Off
Back light compensation (BLC)	<input type="radio"/> On <input checked="" type="radio"/> Off
Mask area	<input type="button" value="Start"/> <input type="button" value="End"/> <input type="button" value="Reset"/>
Light control mode	ELC(1/30s) <input type="button" value="v"/>
AGC	On(High) <input type="button" value="v"/>
Auto slow shutter	Off(1/30s) <input type="button" value="v"/>
Day & Night(electrical)	<input checked="" type="radio"/> Off <input type="radio"/> Auto
White balance	ATW1 <input type="button" value="Set"/>
Red gain	<input type="button" value="-"/> <input type="button" value="128"/> <input type="button" value="Reset"/> <input type="button" value="128"/> <input type="button" value="+"/> <input type="button" value="Reset"/>
Blue gain	<input type="button" value="-"/> <input type="button" value="128"/> <input type="button" value="Reset"/> <input type="button" value="128"/> <input type="button" value="+"/> <input type="button" value="Reset"/>
DNR	<input checked="" type="radio"/> High <input type="radio"/> Low
Chroma gain level	<input type="button" value="-"/> <input type="button" value="128"/> <input type="button" value="Reset"/> <input type="button" value="128"/> <input type="button" value="+"/> <input type="button" value="Reset"/>
Aperture level	<input type="button" value="-"/> <input type="button" value="16"/> <input type="button" value="Reset"/> <input type="button" value="16"/> <input type="button" value="+"/> <input type="button" value="Reset"/>
Pedestal level	<input type="button" value="-"/> <input type="button" value="128"/> <input type="button" value="Reset"/> <input type="button" value="128"/> <input type="button" value="+"/> <input type="button" value="Reset"/>

2. Click the [Start] button of “Mask area”.
 - **VT164W** **VT164**: Borders will appear and the image displayed on the [Image/Position] tab will be divided into 48 (6x8).
 - **VP104W** **VP104**: Borders will appear and the image displayed on the [Image/Privacy] tab will be divided into 48 (6x8).
 - **VP101**: Borders will appear and the image displayed on the [Image/Privacy] tab will be divided into 48 (6x8) (16 (4x4)).

9 Configure the settings relating to images and audio [Image/Audio] (BL-VT164W/BL-VT164)/ Configure the settings relating to images [Image] (BL-VP104W/BL-VP104/BL-VP101)

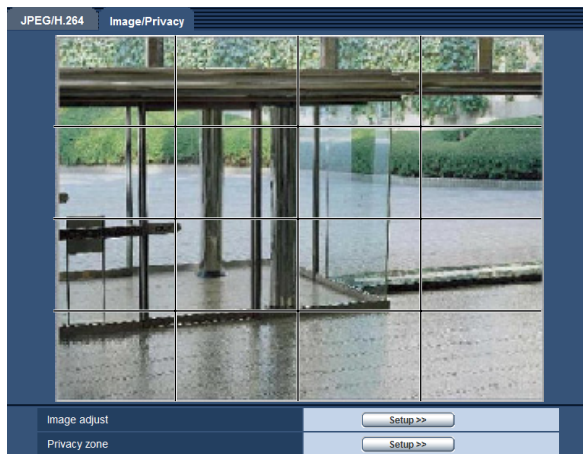
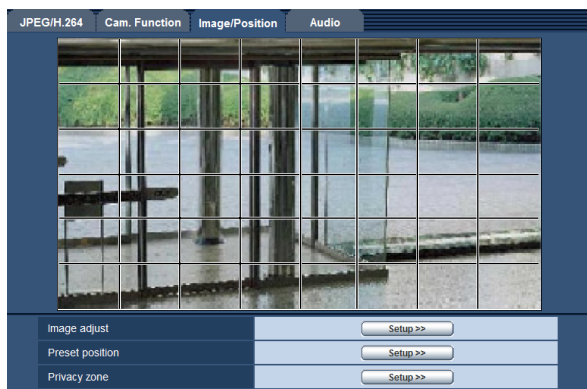

Note

VP101:

- “Mask area” can be set only when “4:3” is selected for “Aspect ratio”. If the “Aspect ratio” is changed to “16:9” after setting the mask area, the setting of the mask area is maintained.

3. Click the divided areas to be masked.

→ The clicked areas will be masked and will become white. To cancel masking, click the area again.

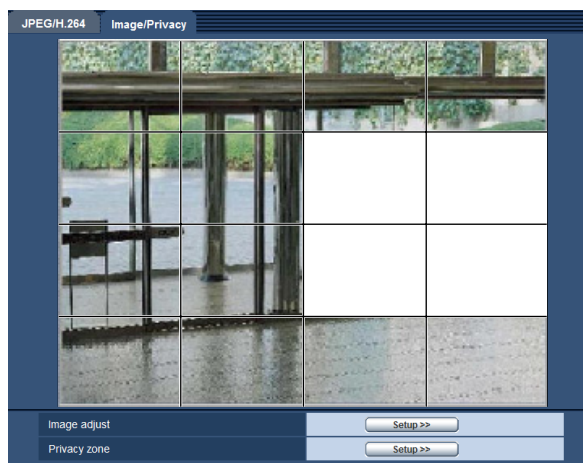
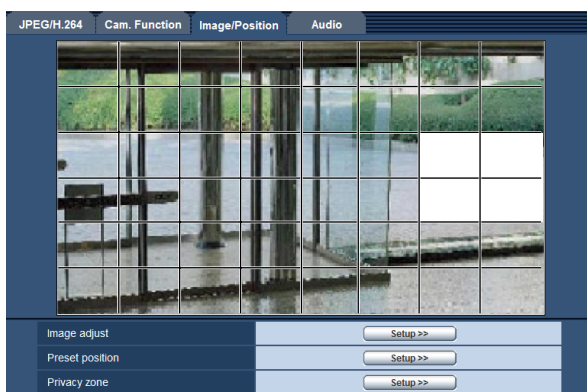

4. Click the [End] button after completing masking areas.

- **VT164W** **VT164**: The borders on the image displayed on the [Image/Position] tab will disappear.
- **VP104W** **VP104** **VP101**: The borders on the image displayed on the [Image/Privacy] tab will disappear.

IMPORTANT

VT164W **VT164** **VP104W** **VP104**:

- When “4:3” is selected for the aspect ratio of JPEG/H.264, the image will be displayed clipped from the image of “16:9”. Therefore even when “4:3” is set, the brightness of the masked area will affect the image. It is recommended that the aspect ratio should be once set to “16:9” before masking.

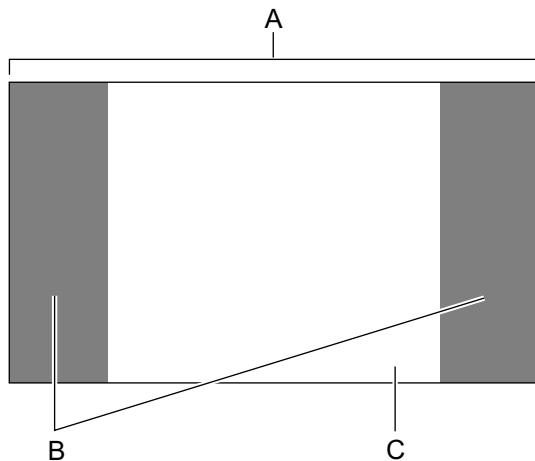

- A. Image in the aspect ratio of "16:9"
- B. Areas where the image is not displayed when "4:3" is selected for the aspect ratio
- C. Image in the aspect ratio of "4:3" (Being cut out from the aspect ratio of "16:9")

VP101 :

- When "16:9" is selected for the aspect ratio of JPEG/H.264, the image will be displayed clipped from the image of "4:3". Therefore even when "16:9" is selected for "Image adjust", the brightness of the masked area will affect the image.



- A. Image in the aspect ratio of "4:3"
- B. Areas where the image is not displayed when "16:9" is selected for the aspect ratio
- C. Image in the aspect ratio of "16:9" (Being cut out from the aspect ratio of 4:3)

Note

- When the [Reset] button is clicked, masking for all the masked areas will be canceled.

9.5.3 Configure the settings relating to the preset positions ("Preset position" setup menu) (BL-VT164W/BL-VT164)

Click the [Setup>>] button of "Preset position" on the [Image/Position] tab of the "Image/Audio" page (→page 57).

It is possible to register, edit and delete the preset positions on this page.

When the brightness and zoom factor are adjusted, the adjustment will be applied immediately to the currently displayed image on the [Image/Position] tab.

9 Configure the settings relating to images and audio [Image/Audio] (BL-VT164W/BL-VT164)/ Configure the settings relating to images [Image] (BL-VP104W/BL-VP104/BL-VP101)

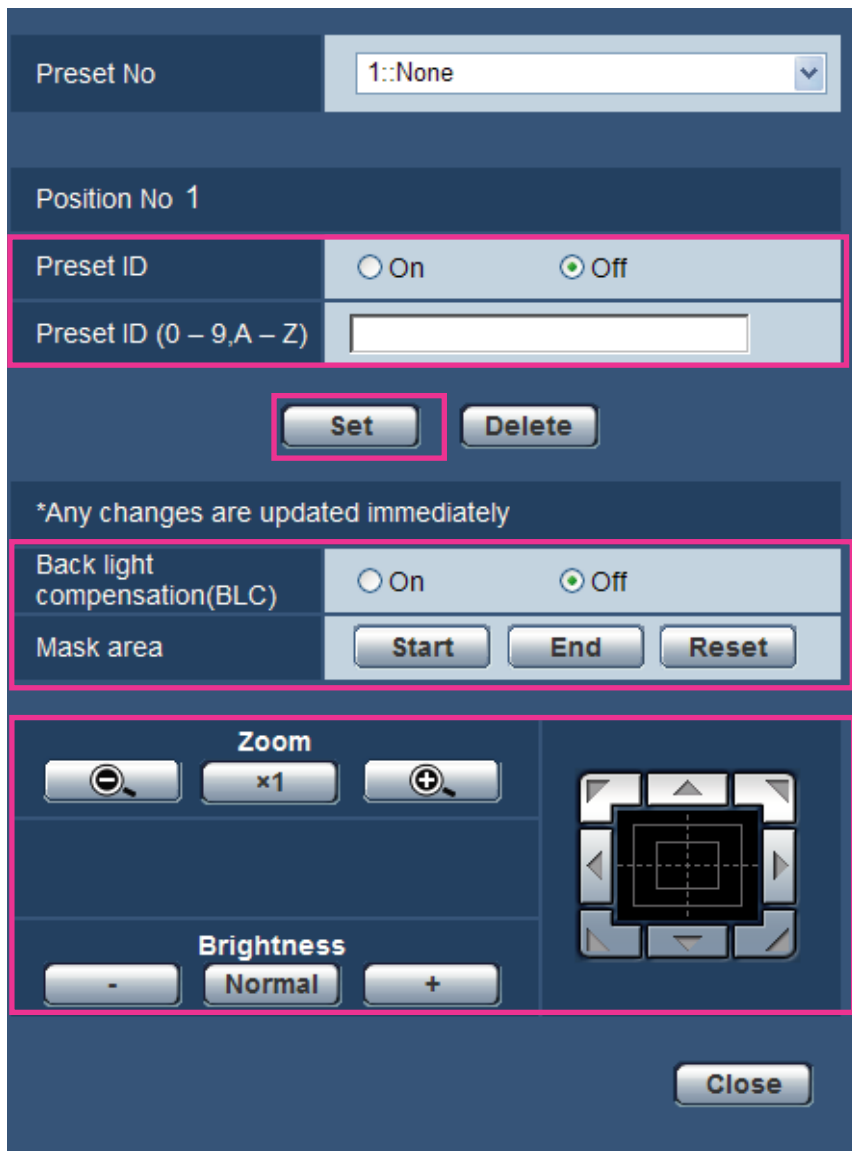

IMPORTANT

- When the zoom factor is 1.5x or more, the setting of the preset positions will become unavailable.

Note

- Depending on the environment (such as when the temperature is below 5° C (41 °F), for example), the moving speed of the camera to the preset position may become slower.

9.5.3.1 Register the preset positions

1. Select a preset position number.
→ The selected preset position number will be displayed in the “Position No” area.
When the selected number has already been registered, the camera will move to the selected preset position.
2. Move the camera to the desired direction.

3. To display the preset ID on the “Live” page, select “On” for “Preset ID” and enter the desired position title to be displayed.
4. Click the [Set] button.
5. The settings for each item such as “Back light compensation (BLC)” can be configured for each position independently. The settings for “Back light compensation (BLC)” and “Mask area” are updated immediately.

Note

- When registering the preset position, the camera direction may move slightly.

Position No

[Preset ID]

Select “On” or “Off” to determine whether to enable or disable the preset ID display. This function can be applied to each preset position.

- **On:** Displays the preset ID.
- **Off:** Does not display the preset ID.
- **Default:** Off

IMPORTANT

- When “Preset ID (0-9,A-Z)” or “Preset ID” is configured, it is necessary to click the [Set] button to apply them.

Note

- When “On” is selected, the entered preset ID will be displayed at the position selected for “OSD” on the “Basic” page. (→page 41)

[Preset ID (0-9,A-Z)]

Enter the preset ID to be displayed on images. This function can be applied to each preset position.

- **Available number of characters:** 0 - 20 characters
- **Available characters:** 0-9, A-Z and the following marks. ! " # \$ % & ' () * + - , . / ; : = ?
- **Default:** None (blank)

Note

- The entered preset ID will be displayed next to the preset position number on the pull-down menu. When “On” is selected for “Preset ID”, the preset ID will be displayed on images.

[Back light compensation (BLC)]

The back light compensation function can compensate back light by setting mask areas on brighter parts of images brighter.

- **On:** Mask areas will be set automatically.
- **Off:** Mask areas will not be set automatically. It is necessary to set them manually.
- **Default:** Off

[Mask area]

When “Off” is selected for “Back light compensation (BLC)”, it is possible to compensate for back light by masking brighter areas.

Refer to page 62 for descriptions of how to mask.

[Zoom] buttons, [Brightness] buttons, Control pad/buttons

Refer to page 10 for descriptions of how to operate these buttons/pad.

[Set] button

Registers the preset positions.

[Delete] button

Deletes the preset position specified by the position number.



[Close] button

Click this button to close the “Preset position” setup menu.

9.5.4 Adjust the angular field of view using the extra zoom function (BL-VP104W/BL-VP104)

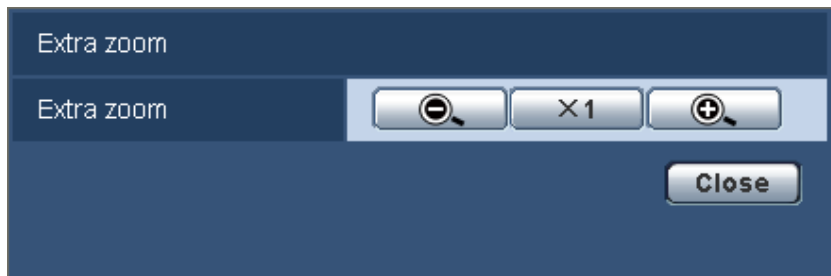
Click the [Setup>>] button of “Extra zoom” on the [Image/Privacy] tab of the “Image” page. (→page 57)
It is possible to adjust the angular field of view using the extra zoom function.



- : Click this button to adjust the zoom ratio to the “Wide” side.
- : Click this button to set the zoom ratio to x1.0.
- : Click this button to adjust the zoom ratio to the “Tele” side.

IMPORTANT

- The extra zoom function may not be activated on the appropriate position if the setting for the function is performed after the settings for the mask areas (→page 62), privacy zone (→page 70), VMD area (→page 84). To prevent this, perform the setting for the extra zoom function before other settings.

9.5.5 Configure the settings relating to the privacy zone (“Privacy zone” setup menu) (BL-VT164W/BL-VT164)

Click the [Setup>>] button of “Privacy zone” on the [Image/Position] tab of the “Image/Audio” page (→page 57).

When there is a zone that you do not want to display, set the zone as a privacy zone not to be displayed. Up to 2 privacy zones can be set.

Note

- The privacy zone function does not work when the camera is in the process of warming-up just after turning on the power, or in the process of refreshing the position.

- Depending on the panning/tilting direction (especially when the tilting degree is 45° - 90°) and the zooming factor, the area set as the privacy zone may become visible. Make sure that each of the set privacy zone is not visible after setting it.

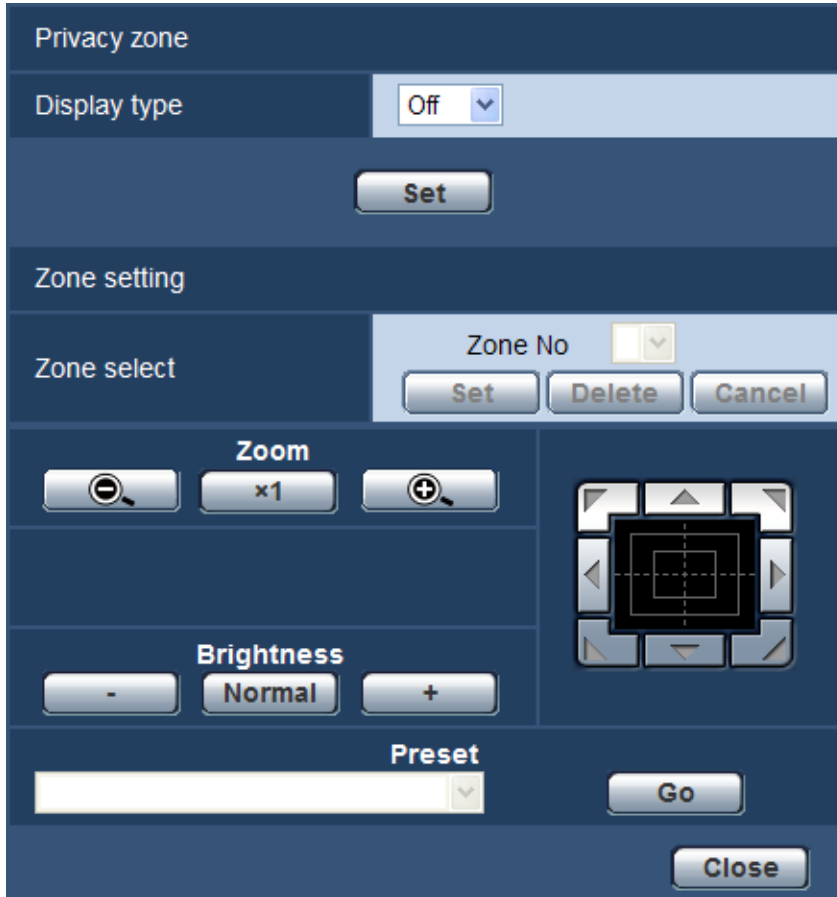

Privacy zone

[Display type]

Select a display type of the privacy zone from the following.

- Gray:** The privacy zones will be displayed in gray.
- Off:** Does not display the privacy zones.
- Default:** Off

Zone setting

[Zone select]

Click [▼] of "Zone No" and select a zone number 1, 2 from the pull-down menu.

An asterisk (*) next to the zone number indicates that the privacy zone has already been set for the number. A blinking mask will be displayed at the center of the image displayed on the [Image/Position] tab.

Operate the camera with the panning/tilting/zooming operations to cover the area to be covered by the blinking mask.

Click the [Set] button after determining the position of the camera.

To delete the registered zone, click the [Delete] button after designating the desired zone number to be deleted. Click the [Cancel] button to cancel the application or to delete the setting.

9 Configure the settings relating to images and audio [Image/Audio] (BL-VT164W/BL-VT164)/ Configure the settings relating to images [Image] (BL-VP104W/BL-VP104/BL-VP101)

Note

- Set the privacy zone larger than the size of an object to be hidden.
- Panning, tilting and zooming operations can also be carried out on the [Image/Position] tab.
- When selecting “Zone No” after selecting “Gray” for “Display type”, a mask will be displayed at the center of the image display area and will start blinking while changing its color as follows: Dark gray → Clear → Light gray
- When the other mask that had already been set is on the same zone, the mask that had previously been set will blink as follows: Dark gray → Light gray

[Zoom] buttons, [Brightness] buttons, Control pad/buttons and [Go] button

Refer to page 10 for descriptions of how to operate these buttons/pad.

[Close] button

Click this button to close the “Privacy zone” setup menu.

9.5.6 Configure the settings relating to the privacy zone (“Privacy zone” setup menu) (BL-VP104W/BL-VP104/BL-VP101)

Click the [Setup>>] button of “Privacy zone” on the [Image/Privacy] tab of the “Image” page. (→page 57)

When there is a zone that you do not want to display, set the zone as a privacy zone not to be displayed. Up to 2 privacy zones can be set.

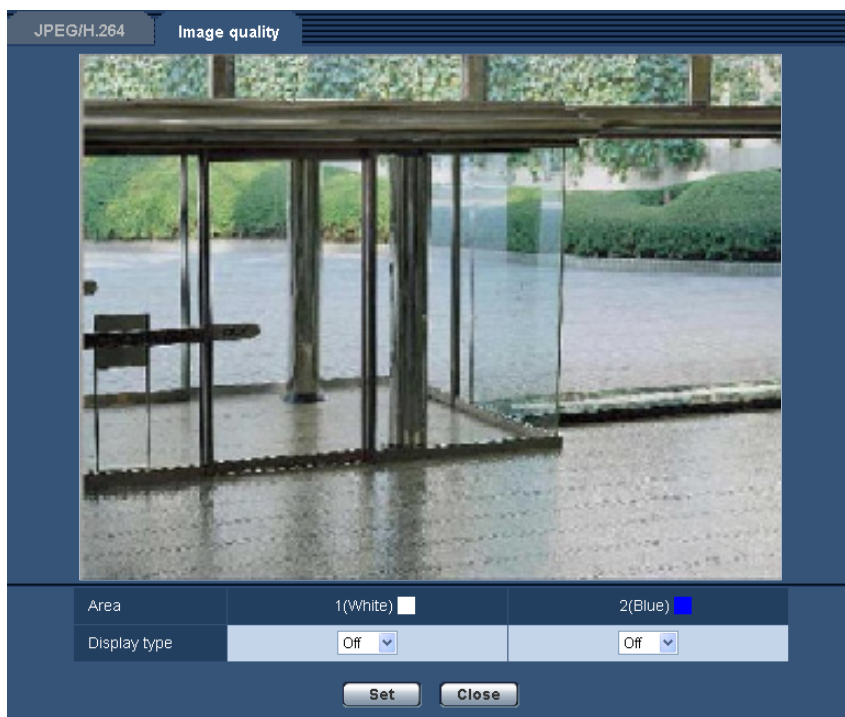

[Area]

The privacy zone will be set when an area is designated by dragging the mouse. Each zone can be overlapped. Privacy zones 1 and 2 can be created and they will be numbered in the order of creation.

[Display type]

Select a display type of the privacy zone from the following.

9 Configure the settings relating to images and audio [Image/Audio] (BL-VT164W/BL-VT164)/ Configure the settings relating to images [Image] (BL-VP104W/BL-VP104/BL-VP101)

- **Gray:** The privacy zones will be displayed in gray.
- **Off:** Does not display the privacy zones.
- **Default:** Off

Note

- Set the privacy zone larger than the size of an object to be hidden.

[Close] button

Click this button to close the “Privacy zone” setup menu.

9.6 Configure the settings relating to audio [Audio] (BL-VT164W/BL-VT164)

Click the [Audio] tab on the “Image/Audio” page. (→page 34, page 35)
The settings relating to audio can be configured on this page.

Note

- Images and audio will not be synchronized. Therefore, images and audio may not always match.
- Audio may be interrupted depending on the network environment.

Setting	Value
Audio transmission/reception	Interactive(Half-duplex)
Audio encoding format	<input checked="" type="radio"/> G.726 <input type="radio"/> G.711
Audio bit rate	32kbps
Mic input volume (Camera to PC)	Mic Middle
Mic input interval (Camera to PC)	40ms
Audio output volume (PC to Camera)	Middle
Audio output interval (PC to Camera)	640ms
Audio output port (PC to Camera)	34004 (1024-50000)
Permission level of audio trans./recep.	<input type="radio"/> 1. Level 1 only <input type="radio"/> 2. Level 2 or higher <input checked="" type="radio"/> 3. All users
Muting while panning/tilting	<input checked="" type="radio"/> On <input type="radio"/> Off

[Audio transmission/reception]

Select the communication mode used for audio data transmission/reception between the camera and the PC from the following.

- **Off:** Does not receive/transmit audio between the camera and the PC. Therefore, the settings and controls relating to audio will be invalidated.
- **Mic input:** The PC receives audio data from the camera. Audio can be heard with images on the PC. Images and audio will not be synchronized.
- **Audio output:** Audio data from the PC will be transmitted to the camera. Audio can be heard from the speaker connected to the camera.
- **Interactive(Half-duplex):** Both reception and transmission are available. However, audio data cannot simultaneously be transmitted and received.
- **Interactive(Full-duplex):** Both reception and transmission are simultaneously available.
- **Default:** Interactive(Half-duplex)

Note

- Howling may be generated depending on usage conditions. If howling is generated, prevent sound generated by the PC from entering the PC microphone.
- When “Multicast” is selected for “Transmission type” on the [JPEG/H.264] tab of the “Image/Audio” page, audio transmission will become unavailable while monitoring H.264 images. To transmit audio from a PC to the camera, click the [JPEG] button on the “Live” page.

[Audio encoding format]

Select the audio encoding format from G.726 and G.711.

- **Default:** G.726

Note

- G.711 is available only when “Mic input” is selected for “Audio transmission/reception”.

[Audio bit rate]

Select “16kbps” or “32kbps” for the audio bit rate used to transmit/receive audio data.

- **Default:** 32kbps

Note

- When selecting a smaller value for “Bandwidth control(bit rate)” (→page 104) while putting a priority on the JPEG/H.264 image transmission, select “16kbps” for “Audio bit rate”.
- [Audio bit rate] is unavailable when “G.711” is selected for “Audio encoding format”.

[Mic input volume (Camera to PC)]

Select a volume level on the PC to hear audio transmitted from the camera.

- **Mic High:** The volume level will become high. This setting will be applied when audio is input to the camera using a microphone.
- **Mic Middle:** The volume level will become middle. This setting will be applied when audio is input to the camera using a microphone.
- **Mic Low:** The volume level will become low. This setting will be applied when audio is input to the camera using a microphone.
- **Line High:** The volume level will become high. This setting will be applied when audio is input to the camera using the Line input.
- **Line Middle:** The volume level will become middle. This setting will be applied when audio is input to the camera using the Line input.
- **Line Low:** The volume level will become low. This setting will be applied when audio is input to the camera using the Line input.
- **Default:** Mic Middle

[Mic input interval (Camera to PC)]

Select an interval for audio reception from the following.

20ms/ 40ms/ 80ms/ 160ms

- **Default:** 160ms

Note

- When a shorter interval is selected, the delay time will be shorter. When a longer interval is selected, audio interruption may be diminished even though the delay time will be longer. Select the interval according to the network environment.

[Audio output volume (PC to Camera)]

Select a volume level on the camera to hear audio transmitted from the PC.

High/ Middle/ Low

- **Default:** Middle

[Audio output interval (PC to Camera)]

Select an interval for audio transmission from the following.

160ms/ 320ms/ 640ms/ 1280ms

- **Default:** 640ms

Note

- When a shorter interval is selected, the delay time will be shorter. When a longer interval is selected, audio interruption may be diminished even though the delay time will be longer. Select the interval according to the network environment.

9 Configure the settings relating to images and audio [Image/Audio] (BL-VT164W/BL-VT164)/ Configure the settings relating to images [Image] (BL-VP104W/BL-VP104/BL-VP101)

- Audio may temporarily be interrupted and noise may be heard when multiple users are accessing the camera concurrently. It may be possible to diminish the interruption or noise by setting a longer interval for “Audio output interval (PC to Camera)”.
- Audio may sometimes not be heard depending on the network environment.

[Audio output port (PC to Camera)]

Enter the transmission port number (the port number on the camera used to receive audio data transmitted from the PC).

- **Available port number:** 1024-50000 (Only even numbers are available.)
- **Default:** 34004

Note

- The transmission port number entered for “Audio output port (PC to Camera)” will be used only when “Unicast port (MANUAL)” is selected for “Transmission type” (→page 49). When “Off” is selected for “H.264 transmission” (→page 49) or when “Unicast port (AUTO)” or “Multicast” is selected for “Transmission type”, it is not necessary to enter the transmission port number.

[Permission level of audio trans./recep.]

Select an access level for audio transmission/reception from the following.

1. Level 1 only/ 2. Level 2 or higher/ 3. All users

- **Default:** 3. All users

Note

- Refer to page 94 and for further information about the access level.

[Muting while panning/tilting]

Select “On” or “Off” to determine whether or not to mute the camera's microphone when the camera is panning or tilting. Select “On” to mute the noise from when the camera is panning or tilting.

- **Default:** On

Note

- When this function is set to “Off”, the microphone will be active when the camera is panning or tilting, and noise from the panning/tilting may be picked up by the microphone.

10 Configure the multi-screen settings [Multi-screen]

The cameras from which images are to be displayed on a multi-screen can be registered on the “Multi-screen” page. (→page 34, page 35)

Multi-screen

Group A	IP address	Camera title
Cam. 1	<input type="text" value="selfcamera"/>	<input type="text" value="BL-VT164"/>
Cam. 2	<input type="text"/>	<input type="text"/>
Cam. 3	<input type="text"/>	<input type="text"/>
Cam. 4	<input type="text"/>	<input type="text"/>

Example of entry: http://192.168.0.10:8080

Group B	IP address	Camera title
Cam. 5	<input type="text"/>	<input type="text"/>
Cam. 6	<input type="text"/>	<input type="text"/>
Cam. 7	<input type="text"/>	<input type="text"/>
Cam. 8	<input type="text"/>	<input type="text"/>

Example of entry: http://192.168.0.10:8080

Group C	IP address	Camera title
Cam. 9	<input type="text"/>	<input type="text"/>
Cam. 10	<input type="text"/>	<input type="text"/>
Cam. 11	<input type="text"/>	<input type="text"/>
Cam. 12	<input type="text"/>	<input type="text"/>

Example of entry: http://192.168.0.10:8080

Group D	IP address	Camera title
Cam. 13	<input type="text"/>	<input type="text"/>
Cam. 14	<input type="text"/>	<input type="text"/>
Cam. 15	<input type="text"/>	<input type="text"/>
Cam. 16	<input type="text"/>	<input type="text"/>

Example of entry: http://192.168.0.10:8080

[IP address]

Enter the IP address or the host name of the camera to be used for the multi-screen. 4 cameras can be registered as a group and up to 4 groups (16 cameras) can be registered.

When the HTTP port number for the camera of which images are to be displayed had been changed, enter as follows:

Example of entry:

10 Configure the multi-screen settings [Multi-screen]

- **Example when entering an IPv4 address:** http://192.168.0.10:8080
- **Example when entering an IPv6 address:** http://[2001:db8:0:0:0:0:1]:8080

To access the cameras using the HTTPS protocol, enter as follows:

Example of entry: https://192.168.0.10/

- **Available number of characters:** 1 - 128 characters
- **Default:** (Cam. 1) selfcamera, (Cam. 2-16) not registered

IMPORTANT

- When accessing the camera using the HTTPS protocol, install the security certificate of the camera to display images on the monitor. (→page 119)

Note

- When using the host name, it is necessary to configure the DNS settings of the PC to be used for the multi-screen display. Refer to the network administrator for information on the DNS setting of PCs.
- This camera is specified when “selfcamera” is displayed for the IP address or host name.

[Camera title]

Enter the title of the camera. The entered camera title will be displayed on a multi-screen.

- **Available number of characters:** 0 - 20 characters
- **Unavailable characters:** " &
- **Default:**
(Cam. 1) Varies as follows depending on the model in use.
BL-VT164W **VT164W** / BL-VT164 **VT164** / BL-VP104W **VP104W** / BL-VP104 **VP104** / BL-VP101 **VP101**
(Cam. 2-16) not registered

Note

- When selecting a 16 split-screen, some characters of the camera title to be displayed may not be displayed.
- Even when “16:9” is selected for “Aspect ratio”, the multi-screen is displayed in 4:3.

11 Configure the alarm settings [Alarm]

The settings relating to alarm occurrences such as settings for the alarm action at an alarm occurrence, the VMD area settings, and the alarm occurrence notification can be configured on this page.

The “Alarm” page has 3 tabs; the [Alarm] tab, the [VMD area] tab and the [Notification] tab.

11.1 Configure the settings relating to the alarm action [Alarm]

Click the [Alarm] tab on the “Alarm” page. (→page 34, page 35)

The settings relating to the alarm can be configured in this section. Refer to page 80 and page 82 for further information about the settings relating to the alarm images and the alarm output terminal.

Alarm		VMD area	Notification
Alarm			
Terminal 1	Off		
Terminal 2	Off		
Terminal 3	Off		
Body heat sensor	Sensitivity Off		
VMD alarm	VMD >>		
Command alarm	Command alarm	<input type="radio"/> On <input checked="" type="radio"/> Off	
Command alarm	Originating port number	8181 (1-65535)	
Set			

Alarm

[Terminal 1] **VT164W** **VT164**

Determine how to use terminal 1.

- **Off:** Not used.
- **Alarm input:** Receives alarms.
 - **Close:** An alarm is detected when the terminal status is changed to “On”.
 - **Open:** An alarm is detected when the terminal status is changed to “Off”.
- **Default:** Off

[Terminal 2] **VT164W** **VT164**

Determine how to use terminal 2.

- **Off:** Not used.
- **Alarm input:** Receives alarms.
 - **Close:** An alarm is detected when the terminal status is changed to “On”.
 - **Open:** An alarm is detected when the terminal status is changed to “Off”.
- **Alarm output:** Alarm output will be carried out according to the settings for “Alarm output terminal setup” (→page 82).
- **Default:** Off

[Terminal 3] **VT164W** **VT164**

Determine how to use terminal 3.

- **Off:** Not used.
- **Alarm input:** Receives alarms.
 - **Close:** An alarm is detected when the terminal status is changed to “On”.
 - **Open:** An alarm is detected when the terminal status is changed to “Off”.
- **AUX output:** AUX output will be supplied. The [AUX] buttons will be displayed on the “Live” page.
- **Default:** Off

Note

- AUX is a camera terminal that allows users to operate (Open/Close) arbitrarily from the “Live” page. For example, an operator can remotely control lights in a place where the camera is installed by connecting the terminal to the light controller.
- Refer to the installation guide for further information about input/output rating of each terminal.
- While “Alarm input” is being selected, an alarm is detected when the terminal status is changed to “On”. (Default)
It is possible to configure the setting so that an alarm is detected when the terminal status is changed to “Off”. When [Fall] is selected after selecting “Alarm input”, an alarm is detected when the terminal status is changed to “On”. When [Rise] is selected, an alarm is detected when the terminal status is changed to “Off”.

[Body heat sensor] **VT164W** **VT164**

Determine how to use the body heat sensor.

- **Off:** Not used.
- **High:** Sets the sensor to a high sensitivity level.
- **Normal:** Sets the sensor to a normal sensitivity level.
- **Low:** Sets the sensor to a low sensitivity level.
- **Quiet:** Sets the sensor to a very low sensitivity level.
- **Default:** Off

Note

- Check the status of the power indicator to determine if the sensor is actually operating or not. (→page 41)
- Because the sensor (body heat sensor) detects temperature differences, the sensor may not make detections depending on the temperature of the object or the surrounding environment, or other factors. In this case, adjust the sensitivity of the sensor.
- In high temperatures the sensor may become less sensitive. In this case we recommend using the [High] setting.
- The sensor and the detection features are not designed to be used for security, surveillance, or other areas that require high reliability. We recommend not using the sensor and detection features in these areas.
- No responsibility will be taken by our company with respect to injuries or other consequences resulting from the use of the sensor and the detection features.

[VMD alarm]

When clicking “VMD >>”, the [VMD area] tab of the “Alarm” page will be displayed. (→page 84)

[Command alarm]

Select “On” or “Off” to determine whether or not to receive the command alarm.

The command alarm is the function that provides notification of a Panasonic protocol alarm from the other cameras. When “On” is selected, alarm actions will be performed between multiple cameras.

- **Default:** Off

[Originating port number]

Select a port number to be used to receive the command alarm.

- **Available range:** 1-65535
- **Default:** 8181

The following port numbers are unavailable since they are already in use.

20, 21, 23, 25, 42, 53, 67, 68, 69, 80, 110, 123, 161, 162, 443, 554, 995, 10669, 10670, 59000-61000

11.2 Configure the settings relating to the camera action on alarm occurrence [Alarm] (BL-VT164W/BL-VT164)

Click the [Alarm] tab on the “Alarm” page. (→page 34, page 35)

The settings relating to the camera action at an alarm occurrence can be configured in this section. Refer to pages 77, 80 and 82 for further information about the settings relating to the alarm, the alarm image and the alarm output terminal.

Camera action on alarm	
Terminal alarm 1	Off
Terminal alarm 2	Off
Terminal alarm 3	Off
Body heat sensor	Off
VMD alarm	Off
Command alarm	Off

Set

Camera action on alarm

[Terminal alarm 1]

Select an action to be taken when a terminal alarm 1 is detected from the following.

- **Off:** Does not take any action even when a terminal alarm 1 is detected.
- **1-64:** When the registered preset position is selected, the camera will move to the selected preset position when a terminal alarm 1 is detected.
- **Default:** Off

[Terminal alarm 2]

Select an action to be taken when a terminal alarm 2 is detected from the following.

- **Off:** Does not take any action even when a terminal alarm 2 is detected.
- **1-64:** When the registered preset position is selected, the camera will move to the selected preset position when a terminal alarm 2 is detected.
- **Default:** Off

[Terminal alarm 3]

Select an action to be taken when a terminal alarm 3 is detected from the following.

- **Off:** Does not take any action even when a terminal alarm 3 is detected.
- **1-64:** When the registered preset position is selected, the camera will move to the selected preset position when a terminal alarm 3 is detected.
- **Default:** Off

[Body heat sensor]

Select an action to be taken when a body heat sensor is detected from the following.

- **Off:** Does not take any action even when a body heat sensor is detected.
- **1-64:** When the registered preset position is selected, the camera will move to the selected preset position when a body heat sensor is detected.
- **Default:** Off

[VMD alarm]

Select an action to be taken when a VMD alarm is detected from the following.

- **Off:** Does not take any action even when a VMD alarm is detected.
- **1-64:** When the registered preset position is selected, the camera will move to the selected preset position when a VMD alarm is detected.
- **Default:** Off

[Command alarm]

Select an action to be taken when a command alarm is detected from the following.

- **Off:** Does not take any action even when a command alarm is detected.
- **1-64:** When the registered preset position is selected, the camera will move to the selected preset position when a command alarm is detected.
- **Default:** Off

11.3 Configure the settings relating to the alarm image [Alarm]

Click the [Alarm] tab on the “Alarm” page. (→page 34, page 35)

The settings relating to the alarm image to be transmitted to an FTP server can be configured in this section. The alarm image will be transmitted to an FTP server. To transmit alarm images to an FTP server, it is necessary to configure the settings in advance. (→page 100)

IMPORTANT

- Depending on the network line speed or the network traffic, images may not be transmitted at the exact designated interval or period.

Alarm image		FTP >>		
Alarm image FTP transmission	<input type="radio"/> On <input checked="" type="radio"/> Off			
Directory name	<input type="text"/>			
File name	<input type="text"/>			
Post alarm	Transmission interval	1fps	Number of images	100 pics
				Recording duration
				100s
Image capture size	640x360			
Image compression rate upon alarm detection	<input type="radio"/> On <input checked="" type="radio"/> Off			
Image quality upon alarm detection	5 Normal			
<input type="button" value="Set"/>				

Alarm image

[FTP >>]

When “FTP >>” is clicked, the [FTP] tab of the “Server” page will be displayed. (→page 100)

[Alarm image FTP transmission]

Select “On” or “Off” to determine whether or not to transmit the alarm image to the FTP server.

- **Default:** Off

[Directory name]

Enter the directory name where the alarm images are to be saved.

For example, enter “/ALARM” to designate the directory “ALARM” under the root directory of the FTP server.

- **Available number of characters:** 1 - 256 characters
- **Unavailable characters:** " & ;

[File name]

Enter the file name used for the alarm image to be transmitted to an FTP server. The file name will be as follows.

File name: [“Entered file name” + “Time and date (year/ month/ day/ hour/ minute/ second)”] + “Serial number”

- **Available number of characters:** 1 - 32 characters
- **Unavailable characters:** " & * / : ; < > ? \ |

[Post alarm]

- **Transmission interval**

Select the transmission interval for the alarm image transmission to the FTP server from the following.
0.1fps/ 0.2fps/ 0.33fps/ 0.5fps/ 1fps

- **Default:** 1fps

- **Number of images**

Select the number of images to be transmitted from the following.

1pic/ 2pics/ 3pics/ 4pics/ 5pics/ 6pics/ 7pics/ 8pics/ 9pics/ 10pics/ 20pics/ 30pics/ 50pics/ 100pics/ 200pics/ 300pics/ 500pics/ 1000pics/ 2000pics/ 3000pics

- **Default:** 100pics

- **Recording duration**

Approximate time to be taken to save the set “Number of images” with the set “Transmission interval” will be displayed.

[Image capture size]

Select the capture size of images to be transmitted to the FTP server or of an image to be attached to the alarm E-mail.

When “4:3” is selected for “Aspect ratio”

VT164W VT164 VP104W VP104 :

QVGA/ VGA/ 800x600

VP101 :

QVGA/ VGA

When “16:9” is selected for “Aspect ratio”

VT164W VT164 VP104W VP104 :

320x180/ 640x360/ 1280x720

VP101 :

320x180/ 640x360

- **Default:** 640x360 VT164W VT164 VP104W VP104 /VGA VP101

[Image compression rate upon alarm detection]

Select “On” or “Off” to determine whether or not to change the image quality of “Quality1” (→page 47) upon alarm detection.

- **On:** Images will be transmitted with the image quality selected for “Image quality upon alarm detection”.
- **Off:** Does not change the image quality upon alarm detection.
- **Default:** Off

[Image quality upon alarm detection]

Image quality can be changed upon an alarm occurrence. Select the image quality from the following.

0 Super fine/ 1 Fine/ 2/ 3/ 4/ 5 Normal/ 6/ 7/ 8/ 9 Low

- **Default:** 5 Normal

Note

- When privacy mode is active, black images will be transmitted.

11.4 Configure the settings relating to the alarm output terminal [Alarm] (BL-VT164W/BL-VT164)

Click the [Alarm] tab on the “Alarm” page. (→page 34, page 35)

The settings relating to the alarm output terminal can be configured in this section.

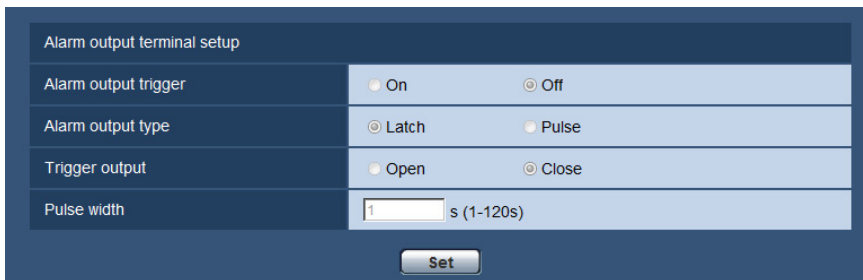

Alarm output terminal setup

[Alarm output trigger]

Select “On” or “Off” to determine whether or not to output the alarm signals to the alarm output terminal when an alarm is detected.

- **Default:** Off

[Alarm output type]

Select “Latch” or “Pulse” for the alarm output terminal at an alarm occurrence.

- **Latch:** When an alarm is detected, the alarm output terminal will be in the state selected for “Trigger output” until the alarm occurrence indication button is clicked.
- **Pulse:** When an alarm is detected, the alarm output terminal will be in the state to the “Trigger output” setting for the period set for “Pulse width”. When the alarm occurrence indication button is clicked, the alarm output terminal will return to the normal state.
- **Default:** Latch

[Trigger output]

Select “Open” or “Close” to determine whether to open or close the alarm output terminal when outputting the alarm signals.

- **Open:** The alarm output terminal will open when outputting the alarm signals. (Normally close)

- **Close:** The alarm output terminal will close when outputting the alarm signals. (Normally open)
- **Default:** Close

Note

- When “Open” is selected, the alarm signal will be output for about 20 seconds when the power of the unit is turned on.

[Pulse width]

When “Pulse” is selected for “Alarm output”, select an alarm output terminal duration from the following.

- **Available range:** 1-120s
- **Default:** 1s

11.5 Change the AUX name [Alarm] (BL-VT164W/BL-VT164)

Click the [Alarm] tab on the “Alarm” page. (→page 34, page 35)

The names of “AUX”, “Open” and “Close” on the “Live” page can be changed.

The screenshot shows a configuration interface with a dark blue header and a light blue background. It contains three input fields stacked vertically, each with a label on the left and a text box on the right. The first field is labeled 'AUX title' and contains the text 'AUX'. The second field is labeled 'Open (Up to 5 characters)' and contains the text 'Open'. The third field is labeled 'Close (Up to 5 characters)' and contains the text 'Close'. Below these fields is a 'Set' button.

AUX title

[AUX (Up to 10 characters)]

Enter the name for “AUX” on the “Live” page.

- **Unavailable characters:** " &
- **Default:** AUX

[Open (Up to 5 characters)]

Enter the name for “Open” of “AUX” on the “Live” page.

- **Unavailable characters:** " &
- **Default:** Open

[Close (Up to 5 characters)]

Enter the name for “Close” of “AUX” on the “Live” page.

- **Unavailable characters:** " &
- **Default:** Close

Note

- AUX is a camera terminal that allows users to operate (Open/Close) arbitrarily from the “Live” page. For example, an operator can remotely control lights in a place where the camera is installed by connecting the terminal to the light controller.

11.6 Configure the VMD settings [VMD area]

Click the [VMD area] tab on the “Alarm” page. (→page 34, page 35)
 The video motion detection areas can be set on this page.

VT164W **VT164** :

The VMD areas can be set up to 4 areas for each preset position (maximum 64 preset positions). When motion is detected in the set area, it will be regarded as an alarm. The camera can be configured to take an alarm action even when the camera is not at the preset position.

VP104W **VP104** **VP101** :

Up to 4 areas can be set. When motion is detected in the set area, it will be regarded as an alarm.

IMPORTANT

- The alarm occurrence indication button (→**VT164W** **VT164** : page 10, **VP104W** **VP104** **VP101** : page 15) will be displayed when motion is detected by the VMD function.
- The alarm occurrence indication button will be displayed when receiving an alarm input of a terminal alarm or a command alarm.
- Depending on the network environment, notification may be delayed even when “Real time” is selected for “Alarm status update mode” on the “Basic” page (→page 39).
- The motion detection function is not the dedicated function to prevent thefts, fires, etc. We are not responsible for any accidents or damages occurring in case.

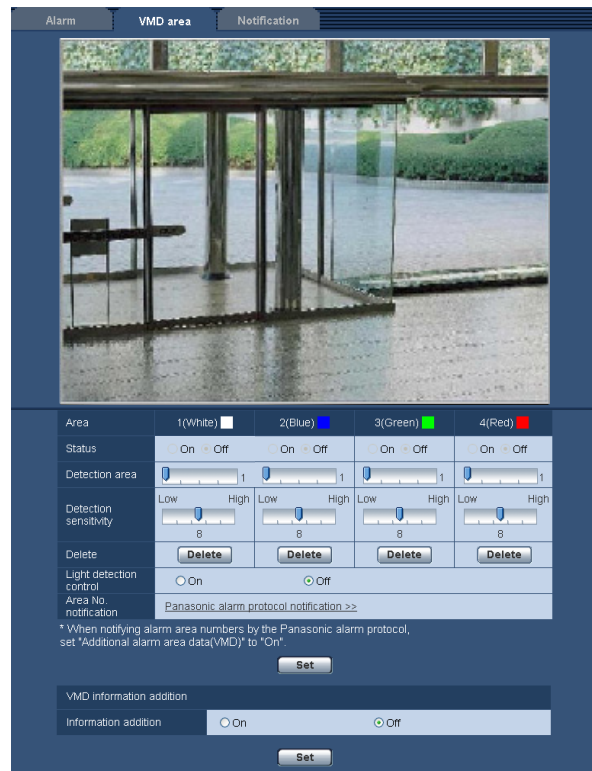
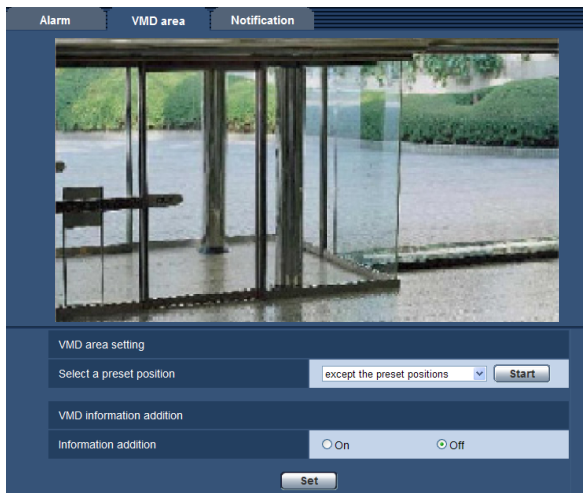

VMD area setting (BL-VT164W/BL-VT164)

[Select a preset position]

Select a preset position number to which the VMD area is to be set, and click the [Start] button.
 When setting an area which is not at the preset position for the VMD area, select VMD activation in area “except the preset positions”.

VMD information addition

[Information addition]

Select “On” or “Off” to determine whether or not to add VMD information to superimposed image data. The VMD information can be searched by some Panasonic network disk recorders. Refer to the operating instructions of the connected devices for further information about the functions and settings.

- **Default:** Off

Procedure for setting the VMD area

Set the areas to activate the VMD function.

IMPORTANT

- When the settings are being configured on the setup menu, sometimes the VMD function may not work correctly.



[Area]

When selecting a VMD area in the screen, it will be numbered as area 1. (Subsequent areas will be numbered in the order of selection.)

[All areas] button VT164W VT164

When the [All areas] button is clicked, the whole area will become the VMD area, and “1(White)” will be automatically applied to “Area”.

[Status]

Select “On” or “Off” to determine whether or not to activate each VMD area.

- **On:** Activates the respective VMD area.
- **Off:** Inactivates the respective VMD area.
- **Default:** Off

[Detection area]

Adjust the size of the VMD area using the slider. The smaller the selected value is, the higher the sensitivity of VMD area becomes. The current value (1-10) will be displayed on the right of the slider.

- **Default:** 1

[Detection sensitivity]

Adjust the sensitivity of motion detection in the VMD area using the slider. The settings can be configured for each area individually. The larger the value is set, the higher the sensitivity level becomes.

The current value (1 (low) - 15 (high)) will be displayed below the slider.

- **Default:** 8

[Delete] button

Click the [Delete] button corresponding to the area to be deleted. The outline of the selected area will be deleted.

[Light detection control]

Select “On” or “Off” to determine whether or not to detect video motion affected by brightness change such by a dimming level control.

- **Default:** Off

IMPORTANT

- “Light detection control” may not work when brightness change is too small.
- When “On” is selected for “Light detection control”, the video motion detection may not be performed even when detecting a subject moving over the whole screen.

[Area No. notification]

When “Panasonic alarm protocol notification >>” is clicked, the [Notification] tab of the “Alarm” page will be displayed. (→page 88)

1. Set the video motion detection area by dragging the mouse on the screen.
When the [All areas] button is clicked, the whole area will become the VMD area, and “1(White)” will be automatically applied to “Area”.
→ The designated area will become the VMD area “1(White)” and the outline will be displayed. When 2 - 4 VMD areas are set, each area will be numbered in order. The areas will be identified by the respective outline colors. The “Status” of the outline to be set for the area will become “On”.
2. Adjust “Detection area” and “Detection sensitivity” using the slider.
“Detection area” can be adjusted by moving the slider between the left end position and the center position.
“Detection sensitivity” can be adjusted by moving the slider between the left end position and the right end position.
The status bar will be indicated in the “Detection area” section to show the motion detection status of the currently displayed area.
When the status bar exceeds the setting position of slider, the alarm action will be performed.

Note

- When “Detection area” cannot be adjusted properly by moving the slider, adjust “Detection sensitivity” while checking the motion detection status.

- Click the [Set] button after completing the settings.

IMPORTANT

- The setting will not be applied unless the [Set] button is clicked.
- To invalidate the VMD area, click the [Set] button after selecting “Off” for “Status” of the VMD area to be invalidated.
 - The outline of the invalidated VMD area will turn to a dotted line. When the VMD area is invalidated, no alarm will occur even when a motion can be recognized in the area.
 - To delete the VMD area, click the [Delete] button corresponding to the area to be deleted.
 - The outline of the respective VMD area will disappear.
 - Click the [Set] button.
 - The edited settings will be applied.
 - Click the [Back] button to return to the screen to select a preset position.

11.7 Configuration of the settings relating to the E-mail notification [Notification]

Click the [Notification] tab on the “Alarm” page. (→page 34, page 35)

The settings relating to the alarm E-mail can be configured. It is necessary to configure the settings of the E-mail server to perform the E-mail notification. (→page 99)

E-mail notification

[E-mail server >>]

When “E-mail server >>” is clicked, the [E-mail] tab of the “Server” page will be displayed. (→page 99)

[E-mail notification]

Select “On” or “Off” to determine whether or not to provide notification by E-mail according to the settings for the “Alarm” and “Diag.” checkboxes of “Destination of notification” below.

- When an alarm is detected (“Alarm”)
- **Default:** Off

[Alarm image attachment]

Select “On” or “Off” to determine whether or not to attach an image to the E-mail to be sent when an alarm is detected.

- **Default:** Off

Note

- The settings for “Image capture size” of the “Alarm image” section on the [Alarm] tab (→page 80) will be applied to the size of the image to be attached.
- When privacy mode is active, black images will be attached.

Destination of notification

[Address 1] - [Address 4]

Enter the destination E-mail address. Up to 4 destination E-mail addresses can be registered.

- **[Alarm] checkbox:** When the checkbox is selected, the E-mail notification will be performed upon an alarm occurrence.
- **[Destination E-mail address]:** Enter the destination E-mail address.
 - **Available number of characters:** 3 - 128 characters
 - **Available characters:** Alphanumeric characters, the at sign (@), the period (.), the underscore (_), and the hyphen (-).

To delete the registered address, click the [Delete] button respective to the desired address.

[E-mail subject]

Enter the E-mail subject.

- **Available number of characters:** 0 - 50 characters

[E-mail body]

Enter the E-mail body.

- **Available number of characters:** 0 - 200 characters

11.8 Configure the settings relating to Panasonic alarm protocol [Notification]

Click the [Notification] tab on the “Alarm” page. (→page 34, page 35)

The settings relating to Panasonic alarm protocol can be configured in this section.

Panasonic alarm protocol notification

[Panasonic alarm protocol]

Select “On” or “Off” to determine whether or not to provide notification by Panasonic alarm protocol according to the settings for the “Alarm” and “Diag.” checkboxes of “Destination of notification” below.

- When an alarm is detected (“Alarm”)
- **Default:** Off

Note

- When “On” is selected for “Alarm”, notification of the alarm occurrence will be provided to the registered destination server addresses in order from “Address 1”.

[Additional alarm area data(VMD)]

Determine whether or not to send notifications for VMD alarm detection area numbers with the Panasonic alarm protocol by selecting On/Off.

- **Default:** Off

[Destination port]

Select a destination port for the Panasonic alarm protocol from the following.

- **Available range:** 1 - 65535
- **Default:** 1818

The following port numbers are unavailable since they are already in use.

20, 21, 23, 25, 42, 53, 67, 68, 69, 80, 110, 123, 161, 162, 443, 995, 10669, 10670

[Retry times]

Select a retry time for the Panasonic alarm protocol.

- **Available range:** 0-30
- **Default:** 2

Destination of notification

[Address 1] - [Address 8]

Enter the destination IP address or host name of the Panasonic alarm protocol from the following. Up to 8 destination server addresses can be registered.

- **[Alarm] checkbox:** When the checkbox is selected, the Panasonic alarm notification will be provided upon an alarm occurrence.
- **[Destination Server address]:** Enter the destination server address or host name.
 - **Available characters:** Alphanumeric characters, the colon (:), the period (.), the underscore (_), and the hyphen (-).

To delete the registered destination server address, click the [Delete] button respective to the desired destination server address.

IMPORTANT

- When entering the host name of the “Destination Server address”, the DNS settings on the [Network] tab of the “Network” page must be configured. (→page 104)
- Confirm that the destination IP addresses are registered correctly. When a registered destination does not exist, notification may be delayed.

12 Configure the setting relating to the image recognition [Advanced func.]

The settings relating to the XML notification and the settings relating to the face detection can be configured on the “Advanced func.” page.

The “Advanced func.” page has 2 tabs; the [XML notification] tab and the [Face detection] tab.

12.1 Configure the settings relating to the XML notification [XML notification]

Click the [XML notification] tab on the “Advanced func.” page.

The settings relating to the XML notification can be configured in this section.

The XML notification notifies the server of face detection information in XML format.

XML notification

[XML notification]

Select “On” or “Off” to determine whether or not to notify face detection information using XML.

12 Configure the setting relating to the image recognition [Advanced func.]

- **Default:** Off

[Notification data]

Select the type of data notification. Select one of the following.

- **Face data**
Detection info.(Original)/Detection info.(Advanced)
Default: Detection info.(Original)

[Notification interval]

Select the notification interval.

- **Face data**
1s/2s/3s/4s/5s/6s/10s/15s/20s/30s/1min
Default: 1s

Note

- When [Notification data] is set to “Detection info.(Original)”, the [Notification interval] can only be set to “1s” or “2s”.

Destination setting for XML notification

[Destination address]

Configure the IP address or the host name of the destination for XML notification.

- **Available number of characters:** 1 - 128 characters
- **Available characters:** Alphanumeric characters, the period (.), the underscore (_), and the hyphen (-).

[Destination port number]

Configure the port number settings for XML notification.

The following port numbers are unavailable since they are already in use.

20, 21, 23, 25, 42, 53, 67, 68, 69, 110, 123, 161, 162, 443, 995, 10669, 10670

[Destination path name]

Configure the settings for the destination directory to be used for the XML notification.

- **Available characters:** Alphanumeric characters, the period (.), the underscore (_), the hyphen (-), the slash (/), and the colon (:).

[User name]

Enter a user name.

- **Available number of characters:** 0 - 32 characters
- **Unavailable characters:** " & ; \
- **Default:** None (blank)

[Password]

Enter a password.

- **Available number of characters:** 0 - 32 characters
- **Unavailable characters:** " &
- **Default:** None (blank)

12.2 Configuration of the settings relating to the face detection [Face detection]

Click the [Face detection] tab on the “Advanced func.” page.

The settings relating to displaying the frame to be used for the face detection and the settings relating to the face detection information attached to the image can be configured.

IMPORTANT

- The face detection function shall not guarantee the detection of faces in an image. The face detection accuracy varies with imaging conditions.



Face detection

[Face detection]

Determine whether or not to enable the face detection function.

- **On:** Information about the face detection frame will be attached and the test frame will be displayed on the image of this page.
- **Off:** Information about the face detection frame will not be attached. No face detection frame will be displayed on the image of this page.
- **Default:** Off

[XML notification]

The destination settings of the face detection information can be configured.

When clicking “XML notification >>”, the [XML notification] tab will be displayed. (→page 91)

13 Configure the settings relating to the authentication [User mng.]

The settings relating to the authentication such as users and PCs restrictions for accessing the camera with a PC or cellular phone/mobile terminal can be configured on the “User mng.” page. The “User mng.” page has 3 tabs; the [User auth.] tab, the [Host auth.] tab and the [System] tab.

13.1 Configure the settings relating to the user authentication [User auth.]

Click the [User auth.] tab on the “User mng.” page. (→page 34, page 35)
The settings relating to the authentication of users who can access this camera from the PC or a cellular phone/mobile terminal can be configured on this page. Up to 18 users can be registered.

Note

- When user authentication has failed to pass (authentication error) 8 times within 30 seconds using the same IP address (PC), access to the unit will be denied for a while.

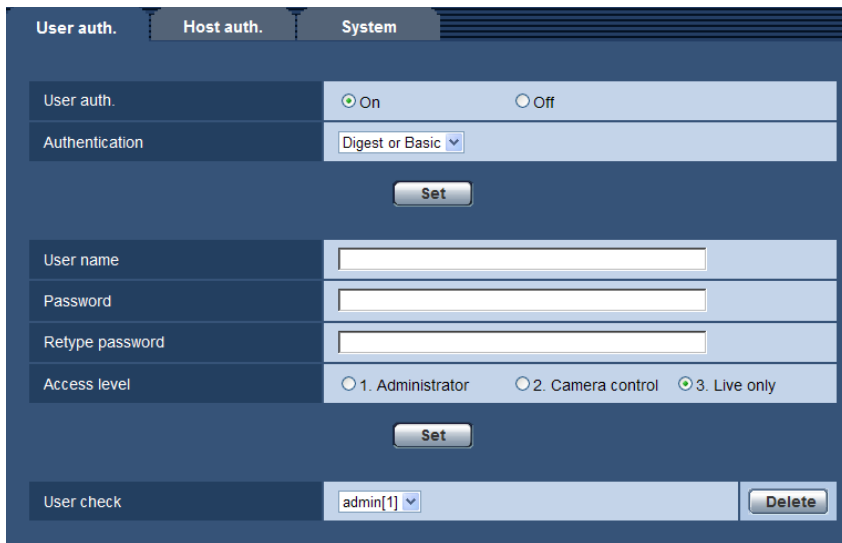

[User auth.]

Select “On” or “Off” to determine whether or not to authenticate the users.

- **Default:** On

[Authentication]

Set the user authentication method.

Digest or Basic: Uses Digest or Basic authentication.

Digest: Uses Digest authentication.

Basic: Uses Basic authentication.

- **Default:** Digest or Basic

Note

- When the [Authentication] setting has been changed, close the web browser, and then access the camera again.

[User name]

Enter a user name.

- **Available number of characters:** 1 - 32 characters
- **Unavailable characters:** " & ; ; \
- **Default:** None (blank)

[Password] [Retype password]

Enter a password.

- **Available number of characters:** 4 - 32 characters
- **Unavailable characters:** " &
- **Default:** None (blank)

Note

- When the user name already in use is entered and the [Set] button is clicked, the respective user information will be overwritten.

[Access level]

Select the access level of the user from the following.

- **1. Administrator:** Allowed all available operations of the camera.
- **2. Camera control:** Allowed to display images from the camera and to control the camera. The camera setting configuration is unavailable.
- **3. Live only:** Only displaying live images is available. The camera setting configuration and camera control are unavailable.
- **Default:** 3. Live only

[User check]

From the pull-down menu of "User check", the registered user can be selected and the selected user's information can be checked.

The registered user will be displayed with the access level.

(Example: admin [1])

To delete the registered user, click the [Delete] button after selecting the user to be deleted.

13.2 Configure the settings relating to the host authentication [Host auth.]

Click the [Host auth.] tab on the "User mng." page. (→page 34, page 35)

13 Configure the settings relating to the authentication [User mng.]

The restriction settings of PCs (IP address) from accessing the camera can be configured on this page.

[Host auth.]

Select “On” or “Off” to determine whether or not to authenticate the host.

- **Default:** Off

[IP address]

Enter the IP address of the PC to be allowed to access the camera. Host name cannot be entered for the IP address.

Note

- When “IP address/subnet mask” is entered, it is possible to restrict PCs in each subnet. For example, when “192.168.0.1/24” is entered and “2. Camera control” is selected for the access level, the PCs whose IP address is between “192.168.0.1” - “192.168.0.254” can access the camera with the access level “2. Camera control”.
- When the IP address already in use is entered and the [Set] button is clicked, the respective host information will be overwritten.

[Access level]

Select the access level of the host from the following.

1. Administrator/ 2. Camera control/ 3. Live only

Refer to page 94 for further information about the access level.

- **Default:** 3. Live only

[Host check]

From the pull-down menu of “Host check”, the registered host can be selected and the selected host’s IP address can be checked.

The registered IP address will be displayed with the access level.

(Example: 192.168.0.21 [1])

To delete the registered host, click the [Delete] button after selecting the IP address to be deleted.

13.3 Configure the settings relating to the priority stream [System]

Click the [System] tab on the “User mng.” page. (→page 34, page 35)

The description below is the configuration of the priority stream that can transmit images without deteriorating the image quality and refresh interval even when multiple users access concurrently.

User auth.	Host auth.	System
Priority stream		
Activation	<input type="radio"/> On <input checked="" type="radio"/> Off	
Destination IP address(1)	<input type="text"/>	
Destination IP address(2)	<input type="text"/>	
Stream type	JPEG	
Refresh interval*	1fps	
Image capture size	640x360	
<input type="button" value="Set"/>		

Priority stream

[Activation]

Select "On" or "Off" to determine whether or not to use the priority stream.

- **Default:** Off

Note

- When "On" is selected for "Activation" of "Priority stream", number of users who can access the camera may be limited.

[Destination IP address(1)]

Enter the first destination IP address.

[Destination IP address(2)]

Enter the second destination IP address.

[Stream type]

Select either "JPEG", "H.264(1)" or "H.264(2)".

- **JPEG:** JPEG images will be transmitted.
- **H.264(1):** H.264(1) images will be transmitted.
- **H.264(2):** H.264(2) images will be transmitted.
- **Default:** JPEG

Note

- When "Best effort" is selected for "Transmission priority" of "H.264", bit rate will vary between the maximum and minimum rates while images are being transmitted.

[Refresh interval*]

Select the refresh interval from the following.

This setting is validated only when "JPEG" is selected for "Stream type".

0.1fps/ 0.2fps/ 0.33fps/ 0.5fps/ 1fps/ 2fps/ 3fps/ 5fps/ 6fps*/ 10fps*/ 12fps*/ 15fps*/ 30fps*

- **Default:** 1fps

Note

- When "On" is selected for "H.264 transmission", the transmission interval may be longer than the set value when any value with an asterisk (*) on the right is selected.

[Image capture size]

Select the image capture size from the following.

This setting is validated only when "JPEG" is selected for "Stream type".

When "4:3" is selected for "Aspect ratio"

VT164W VT164 VP104W VP104 :

QVGA/ VGA/ 800x600

VP101 :

QVGA/ VGA

When "16:9" is selected for "Aspect ratio"

VT164W VT164 VP104W VP104 :

320x180/ 640x360/ 1280x720

VP101 :

320x180/ 640x360

- **Default:** 640x360 VT164W VT164 VP104W VP104 /VGA VP101

14 Configure the settings of the servers [Server]

The settings relating to the E-mail server, the FTP server and the NTP server can be configured on this page. The “Server” page has 3 tabs; the [E-mail] tab, the [FTP] tab and the [NTP] tab.

14.1 Configure the settings relating to the E-mail server [E-mail]

Click the [E-mail] tab on the “Server” page. (→page 34, page 35)

The settings relating to the E-mail server used to send the alarm E-mail can be configured on this page.

IMPORTANT

- When a terminal that receives E-mails is not compatible with UTF-8 encode, it is impossible to receive alarm E-mails correctly.

[SMTP server address]

Enter the IP address or the host name of the SMTP server used to send E-mails.

- **Available number of characters:** 1 - 128 characters
- **Available characters:** Alphanumeric characters, the colon (:), the period (.), the underscore (_), and the hyphen (-).

[SMTP port]

Enter the port number to which E-mails are sent.

- **Available port number:** 1-65535
- **Default:** 25

The following port numbers are unavailable since they are already in use.

20, 21, 23, 42, 53, 67, 68, 69, 80, 110, 123, 161, 162, 443, 995, 10669, 10670

[POP server address]

When “POP before SMTP” is selected for “Type”, enter the IP address or the host name of the POP server.

- **Available number of characters:** 1 - 128 characters
- **Available characters:** Alphanumeric characters, the colon (:), the period (.), the underscore (_), and the hyphen (-).

IMPORTANT

- When entering the host name for “SMTP server address” or “POP server address”, it is necessary to configure the DNS settings on the [Network] tab of the “Network” page. (→page 104)

[Authentication]

- **Type**
Select the authentication method to send E-mails from the following.
 - **None:** It is not necessary to clear any authentication to send E-mails.
 - **POP before SMTP:** It is necessary to first clear the POP server authentication to use the SMTP server to send E-mails.
 - **SMTP:** It is necessary to clear the SMTP server authentication to send E-mails.
 - **Default:** None

Note

- When you don't know the authentication method to send E-mails, refer to the network administrator.
- **User name**
Enter the user name to access the server.
 - **Available number of characters:** 0 - 32 characters
 - **Unavailable characters:** " & ; \
- **Password**
Enter the password to access the server.
 - **Available number of characters:** 0 - 32 characters
 - **Unavailable characters:** " &

[Sender's E-mail address]

Enter the E-mail address of a sender.

The entered E-mail address will be displayed in the “From” (sender) line of the sent E-mails.

- **Available number of characters:** 3 - 128 characters
- **Available characters:** Alphanumeric characters, the at sign (@), the period (.), the underscore (_), and the hyphen (-).

14.2 Configure the settings relating to the FTP server [FTP]

Click the [FTP] tab on the “Server” page. (→page 34, page 35)

The settings relating to the FTP server used to transmit the alarm images can be configured on this page.

E-mail	FTP	NTP
FTP server address	<input type="text"/>	
User name	<input type="text"/>	
Password	<input type="text"/>	
Control port	<input type="text" value="21"/> (1-65535)	
FTP mode	<input checked="" type="radio"/> Passive <input type="radio"/> Active	

[FTP server address]

Enter the IP address or the host name of the FTP server.

- **Available number of characters:** 1 - 128 characters
- **Available characters:** Alphanumeric characters, the colon (:), the period (.), the underscore (_), and the hyphen (-).

IMPORTANT

- When entering the host name for “FTP server address”, it is necessary to configure the DNS settings on the [Network] tab of the “Network” page. (→page 104)

[User name]

Enter the user name (login name) to access the FTP server.

- **Available number of characters:** 1 - 32 characters
- **Unavailable characters:** " & ; ; \

[Password]

Enter the password to access the FTP server.

- **Available number of characters:** 0 - 32 characters
- **Unavailable characters:** " &

[Control port]

Enter a control port number to be used for the FTP server.

- **Available port number:** 1-65535
- **Default:** 21

The following port numbers are unavailable since they are already in use.

20, 23, 25, 42, 53, 67, 68, 69, 80, 110, 123, 161, 162, 443, 995, 10669, 10670

[FTP mode]

Select “Passive” or “Active” for the FTP mode.

Normally, select “Passive”. When it is impossible to connect after select “Passive”, try to connect after selecting “Active”.

- **Default:** Passive

14.3 Configure the settings relating to the NTP server

[NTP]

Click the [NTP] tab on the “Server” page. (→page 34, page 35)

The settings relating to the NTP server such as the NTP server address, port number, etc. can be configured on this page.

IMPORTANT

- Use an NTP server when the more accurate time & date setting is required for the system operation.

E-mail	FTP	NTP
Time adjustment		
<input checked="" type="radio"/> Manual <input type="radio"/> Synchronization with NTP server		
NTP server address setting		
Manual		
NTP server address		
<input type="text"/>		
NTP port		
123 (1-65535)		
Time adjustment interval		
1h		
Time zone		
(GMT) Greenwich Mean Time : Dublin, Edinburgh, Lisbon, London		
Set		

[Time adjustment]

Select the time adjustment method from the following. Time adjusted by the selected method will be used as the standard time of the camera.

- **Manual:** Time set on the “Basic” page will be used as the standard time of the camera.
- **Synchronization with NTP server:** Time automatically adjusted by synchronizing with the NTP server will be used as the standard time of the camera.
- **Default:** Manual

[NTP server address setting]

When “Synchronization with NTP server” is selected for “Time adjustment”, select the method of how to obtain the NTP server address from the following.

- **Auto:** Obtains the NTP server address from the DHCP server.
- **Manual:** The NTP server address will be entered manually on “NTP server address”.
- **Default:** Manual

IMPORTANT

- When obtaining the NTP server address from the DHCP server, it is necessary to select “DHCP”, “Auto(AutoIP)”, or “Auto(Advanced)” for “Network Settings” on the [Network] tab of the “Network” page. (→page 104)

[NTP server address]

When “Manual” is selected for “NTP server address setting”, enter the IP address or the host name of the NTP server.

- **Available number of characters:** 1 - 128 characters
- **Available characters:** Alphanumeric characters, the colon (:), the period (.), the underscore (_), and the hyphen (-).
- **Default:** None (blank)

IMPORTANT

- When entering the host name for “NTP server address”, it is necessary to configure the DNS settings on the [Network] tab of the “Network” page. (→page 104)

[NTP port]

Enter a port number of the NTP server.

- **Available port number:** 1 - 65535
- **Default:** 123

The following port numbers are unavailable since they are already in use.
20, 21, 23, 25, 42, 53, 67, 68, 69, 80, 110, 161, 162, 443, 995, 10669, 10670

[Time adjustment interval]

Select an interval (1 - 24 hours: in 1 hour intervals) of synchronization with the NTP server.

- **Default:** 1h

[Time zone]

Select a time zone corresponding to the location where the camera is in use.

- **Default:** (GMT) Greenwich Mean Time: Dublin, Edinburgh, Lisbon, London

15 Configuring the network settings [Network]

The network settings and the settings relating to DDNS (Dynamic DNS) and SNMP (Simple Network management Protocol) can be configured on the “Network” page.

The “Network” page has 4 tabs; the [Network] tab, the [DDNS] tab, the [SNMP] tab and the [FTP img. trans.] tab.

15.1 Configure the network settings [Network]

Click the [Network] tab on the “Network” page. (→page 34, page 35)

The following information is required to configure the network settings. Contact the network administrator or your Internet service provider.

- IP address
- Subnet mask
- Default gateway (when using the gateway server/router)
- HTTP port
- Primary DNS address, Secondary DNS address (when using DNS)

The screenshot displays the 'Network' configuration page with the following settings:

- IPv4 network:**
 - Network Settings: Auto(Advanced)
 - IP address(Pv4): 192.168.0.10
 - Subnet mask: 255.255.255.0
 - Default gateway: 192.168.0.1
 - DNS: Manual
 - Primary server address: 0.0.0.0
 - Secondary server address: 0.0.0.0
- IPv6 network:**
 - Manual: Off
 - IP address(Pv6):
 - DHCPv6: Off
 - Primary DNS server address:
 - Secondary DNS server address:
- Common:**
 - HTTP port: 80 (1-65535)
 - Line speed: Auto
 - Max RTP packet size: Limited(1280byte)
 - HTTP max segment size(MSS): Limited(1280byte)
- UPnP:**
 - Auto port forwarding: Off
 - Camera short cut: Off
- HTTPS:**
 - CRT key generate: Execute
 - Self-signed Certificate:
 - Generate: Execute
 - Information: Not generated (Confirm, Delete)
 - Generate Certificate Signing Request: Execute
 - CA Certificate:
 - CA Certificate install: Browse, Execute
 - Information: Invalid (Confirm, Delete)
 - Connection: HTTP
 - HTTPS port: 443 (1-65535)
- FTP access to camera:** Forbid
- Bandwidth control(bit rate):** Unlimited
- Easy IP Setup accommodate period:** 20min

IPv4 network

[Network Settings]

Select the method of how to configure the IP address from the following.

- **Static:** The IP address is configured by entering manually on "IP address(IPv4)".
- **DHCP:** The IP address is configured using the DHCP function.
- **Auto(AutoIP):** The IP address is configured using the DHCP function. When the DHCP server is not found, the IP address is automatically configured.
- **Auto(Advanced):** The IP address and other network addresses are obtained using the DHCP function. Available IP addresses are determined by searching for IP addresses. When the DHCP server is not found, the IP address is set to 192.168.0.10, or the already determined IP addresses are used the same way as static IP addresses.

- **Default:** Auto(Advanced)

Note

- When “Auto(AutoIP)” is selected and the IP address cannot be obtained from the DHCP server, an IP address not used in the same network will be searched within 169.254.1.0 - 169.254.254.255.

[IP address(IPv4)]

When not using the DHCP function, enter the IP address of the camera. Do not enter an IP address already in use (for the PCs and the other network cameras).

- **Default:** 192.168.0.10

Note

- Multiple IP addresses are unavailable even when using the DHCP function. Refer to the network administrator for further information about the settings of the DHCP server.

[Subnet mask]

When not using the DHCP function, enter the subnet mask of the camera.

- **Default:** 255.255.255.0

[Default gateway]

When not using the DHCP function, enter the default gateway of the camera.

- **Default:** 192.168.0.1

Note

- Multiple IP addresses for the default gateway are unavailable even when using the DHCP function. Refer to the network administrator for further information about the settings of the DHCP server.

[DNS]

Determine how to set the address of the DNS server by selecting “Auto” (obtain the address automatically) or “Manual” (enter the address of the DNS server). When “Manual” is selected, it is necessary to configure the settings for the DNS.

When using the DHCP function, it is possible to obtain the DNS address automatically by selecting “Auto”. Refer to the network administrator for further information about the settings.

- **Default:** Auto

[Primary server address], [Secondary server address]

When “Manual” is selected for “DNS”, enter the IP address of the DNS server. Refer to the network administrator about the IP address of the DNS server.

IPv6 network

[Manual]

Select “On” or “Off” to determine whether or not to manually configure the IP address for IPv6 network (IPv6 address).

- **On:** Enter an IPv6 address manually.
- **Off:** Manual entry of an IPv6 address will become unavailable.
- **Default:** Off

[IP address(IPv6)]

When “On” is selected for “Manual”, manual entry of the IPv6 address is required. Do not enter an address already in use.

Note

- When connecting to the manually configured IPv6 address beyond the router, use an IPv6 compatible router and turn on the automatic IPv6 address assignment function. In this case, it is necessary to configure IPv6 address including prefix information provided from the IPv6 compatible router. Refer to the manuals provided with the router for further information.

[DHCPv6]

Select “On” or “Off” to determine whether or not to use the IPv6 DHCP function.

Configure the DHCP server not to assign the same IP addresses used for the other network cameras and PCs whose IP address is unique. Refer to the network administrator for further information about the settings of the server.

- **Default:** Off

[Primary DNS server address], [Secondary DNS server address]

Enter the IPv6 address of the DNS server. Refer to the network administrator about the IPv6 address of the DNS server.

Common**[HTTP port]**

Assign the port numbers independently.

- **Available port number:** 1 - 65535
- **Default:** 80

The following port numbers are unavailable since they are already in use.

20, 21, 23, 25, 42, 53, 67, 68, 69, 110, 123, 161, 162, 443, 554, 995, 10669, 10670, 59000 - 61000

[Line speed]

Select the line speed for data transmission from the following. It is recommended to use with the default “Auto”.

- **Auto:** Line speed will be applied automatically.
- **100M-Full:** 100 Mbps full-duplex
- **100M-Half:** 100 Mbps half-duplex
- **10M-Full:** 10 Mbps full-duplex
- **10M-Half:** 10 Mbps half-duplex
- **Default:** Auto

[Max RTP packet size]

Select “Unlimited(1500byte)” or “Limited(1280byte)” to determine whether or not to restrict the RTP packet size when viewing images from the camera using the RTP protocol. It is recommended to use with the default setting.

When the RTP packet size is restricted in the network line in use, select “Limited(1280byte)”. Refer to the network administrator for further information about the maximum packet size in the network line.

- **Default:** Limited(1280byte)

[HTTP max segment size(MSS)]

Select “Limited(1024byte)”, “Limited(1280byte)”, or “Unlimited(1460byte)” to determine whether or not to restrict the maximum segment size (MSS) when viewing images from the camera using the HTTP protocol. It is recommended to use with the default setting.

When the MSS is restricted in the network line in use, select “Limited(1024byte)” or “Limited(1280byte)”. Refer to the network administrator for further information about the MSS in the network line.

- **Default:** Limited(1280byte)

UPnP

This camera support UPnP (Universal Plug and Play). By using the UPnP function, it becomes possible to configure the following automatically.

- Configuration of the port forwarding function of the router (However, a router supporting UPnP is required.) This configuration is useful when accessing the camera via the Internet or from a cellular phone/mobile terminal.
- Automatic refreshment of the shortcut to the camera that is created on the [My Network Places] folder ([Network] folder when using Windows Vista or Windows 7) of the PC even when the IP address of the camera changes.

[Auto port forwarding]

Select “On” or “Off” to determine whether or not to use the port forwarding function of the router.

To use the port forwarding function, the router in use must support UPnP and the UPnP must be enabled.

- **Default:** Off

Note

- Due to port forwarding, the port number may sometimes be changed. When the number is changed, it is necessary to change the port numbers registered in the PC and recorders, etc.
- The UPnP function is available when the camera is connected to the IPv4 network. IPv6 is not supported.
- To check if auto port forwarding is properly configured, click the [Status] tab on the “Maintenance” page, and check that the “Enable” is displayed for “Status” of “UPnP”. (→page 156)
When “Enable” is not displayed, refer to “Cannot access the camera via the Internet.” in the “22 Troubleshooting” section. (→page 170)

[Camera short cut]

Select whether or not to create the shortcut to the camera on the [My Network Places] folder ([Network] folder when using Windows Vista or Windows 7) of the PC. When creating the shortcut, select “On”.

To use the shortcut function to the camera, enable the UPnP function on the PC in advance.

- **Default:** Off

Note

- To display the shortcut to the camera on the [My Network Places] folder ([Network] folder when using Windows Vista or Windows 7) of the PC, it is necessary to add the Windows component. Refer to the following to enable the UPnP function.

For Windows XP

[Start] → [Settings] → [Control Panel] → [Add or Remove Programs] → [Add/Remove Windows Components] → select [Networking Services] → [Details] → check [Internet Gateway Device Discovery and Control Client] and [UPnP User Interface] → [OK] → [Next] → Complete

For Windows Vista

[Start] → [Control Panel] → [Network and Internet] → [Network and Sharing Center] → expand the section of [Network discovery] of [Sharing and Discovery] → select [Turn on network discovery] → click [Apply] → Complete

For Windows 7

[Start] → [Control Panel] → [Network and Internet] → [Network and Sharing Center] → select [Turn on network discovery] of [Network discovery] of [Change advanced sharing settings] → click [Save changes] → Complete

HTTPS

It is possible to enhance the network security by encrypting the access to cameras using the HTTPS function. Refer to page 112 for how to configure the HTTPS settings.

[CRT key generate]

CRT key (SSL encryption key) used for the HTTPS protocol is generated. To generate the CRT key, click the [Execute] button to display “CRT key generate” dialog box.

[Self-signed Certificate - Generate]

The camera itself generates the security certificate used for the HTTPS protocol. (Self-signed certificate)
To generate the self-signed certificate, click the [Execute] button to display the “Self-signed Certificate - Generate” dialog box.

[Self-signed Certificate - Information]

Displays the information of the self-signed certificate.

When the [Confirm] button is clicked, the registered information of the self-signed certificate will be displayed in the “Self-signed Certificate - Confirm” dialog box.

When the [Delete] button is clicked, the generated self-signed certificate will be deleted.

[CA Certificate - Generate Certificate Signing Request]

When using the security certificate issued by CA (Certificate Authority) as the security certificate used for the HTTPS protocol, the CSR (Certificate Signing Request) will be generated.

To generate the CSR, click the [Execute] button to display the “CA Certificate - Generate Certificate Signing Request” dialog window.

[CA Certificate - CA Certificate install]

Installs the server certificate (security certificate) issued by CA (Certificate Authority) and displays the information of the installed server certificate.

To install the server certificate, click the [Browse...] button to display the [Open] dialog box, and select the file of the server certificate issued by CA, and click the [Execute] button.

If the server certificate is already installed, the file name of the installed server certificate will be displayed.

[CA Certificate - Information]

Displays the information of the server certificate.

When the [Confirm] button is clicked, the registered information of the installed server certificate will be displayed in the “CA Certificate - Confirm” dialog box. If the server certificate is not installed, the content of the generated CSR file will be displayed.

When the [Delete] button is clicked, the installed server certificate will be deleted.

IMPORTANT

- Before deleting the valid server certificate (security certificate), confirm that there is a backup file on the PC or another media. The backup file will be required when installing the server certificate again.

[Connection]

Select the protocol used to connect the camera.

- **HTTP:** Only the HTTP connection is available.
- **HTTPS:** Only the HTTPS connection is available.
- **Default:** HTTP

[HTTPS port]

Designate the HTTPS port number to be used.

- **Available port number:** 1 - 65535
- **Default:** 443

The following port numbers are unavailable since they are already in use.

20, 21, 23, 25, 42, 53, 67, 68, 69, 80, 110, 123, 161, 162, 554, 995, 10669, 10670, 59000-61000

Note

- The camera will restart after the connection setting is changed.
- **When using the self-signed certificate:**
If the camera is accessed using the HTTPS protocol for the first time, the warning window will be displayed. In this case, follow the instructions of the wizard to install the self-signed certificate. (→page 119)
- **When using the server certificate:**
In advance, install the root certificate and intermediate certificate on the browser in use. Follow the instructions of CA for how to obtain and install these certificates.
- When the camera is accessed using the HTTPS protocol, the refresh interval and frame rate of images may be lower.
- When the camera is accessed using the HTTPS protocol, it may take time to display images.
- When the camera is accessed using the HTTPS protocol, the images may be distorted or audio may be interrupted.
- The maximum number of concurrent access user varies depending on the maximum image size and transmission format.

[FTP access to camera]

Select “Allow” or “Forbid” to determine whether to allow or forbid the FTP access to camera.

- **Default:** Forbid

[Bandwidth control(bit rate)]

Select the total bit rate for data transmission from the following.

Unlimited/ 64kbps/ 128kbps/ 256kbps/ 384kbps/ 512kbps/ 768kbps/ 1024kbps/ 2048kbps/ 4096kbps/ 8192kbps

- **Default:** Unlimited

Note

- When selecting “64kbps”, select “Off” for “Audio transmission/reception” on the [Audio] tab. (→page 72)
- Select “128kbps” or a faster rate to carry out the live transmission of JPEG images and the FTP periodic image transmission simultaneously.
- When “Bandwidth control(bit rate)” is set low, taking a picture using the snap shot button may not function depending on the use environment. In this case, select “QVGA” for “Image capture size” of “JPEG” on the [JPEG/H.264] tab or set “Image quality setting” of “JPEG” lower.

[Easy IP Setup accommodate period]

Select “20min” or “Unlimited” to determine how long the network setting operation using the Panasonic “IP Setting Software” can be allowed.

- **20min:** The camera and the network setting operation using the Panasonic “IP Setting Software” are allowed for 20 minutes since the camera starts up.
- **Unlimited:** The camera and the network setting operation using the Panasonic “IP Setting Software” are allowed without time limitation.
- **Default:** 20min

Note

- Refer to the network administrator for the addresses of each server.
- The port forwarding function changes a global IP address to a private IP address, and “Static IP masquerade” and “Network Address Translation (NAT)” have this function. This function is to be set in a router.

- To access the camera via the Internet by connecting the camera to a router, it is necessary to assign a respective HTTP port number for each camera and address translation by using the port forwarding function of the router. For further information, refer to the operating instructions of the router in use.

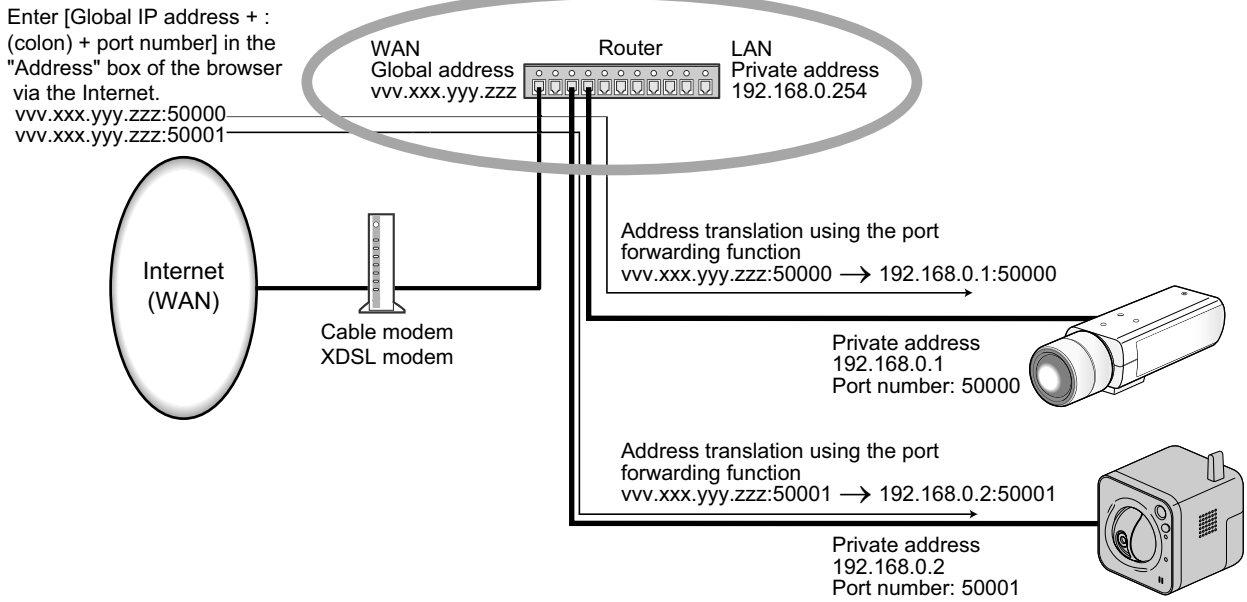

15.2 Configure the HTTPS settings

Click the [Network] tab on the “Network” page. (→page 34, page 35)

The settings relating to the HTTPS protocol that can enhance the network security by encrypting the access to cameras on this page.

The HTTPS settings will be configured in the following procedure.

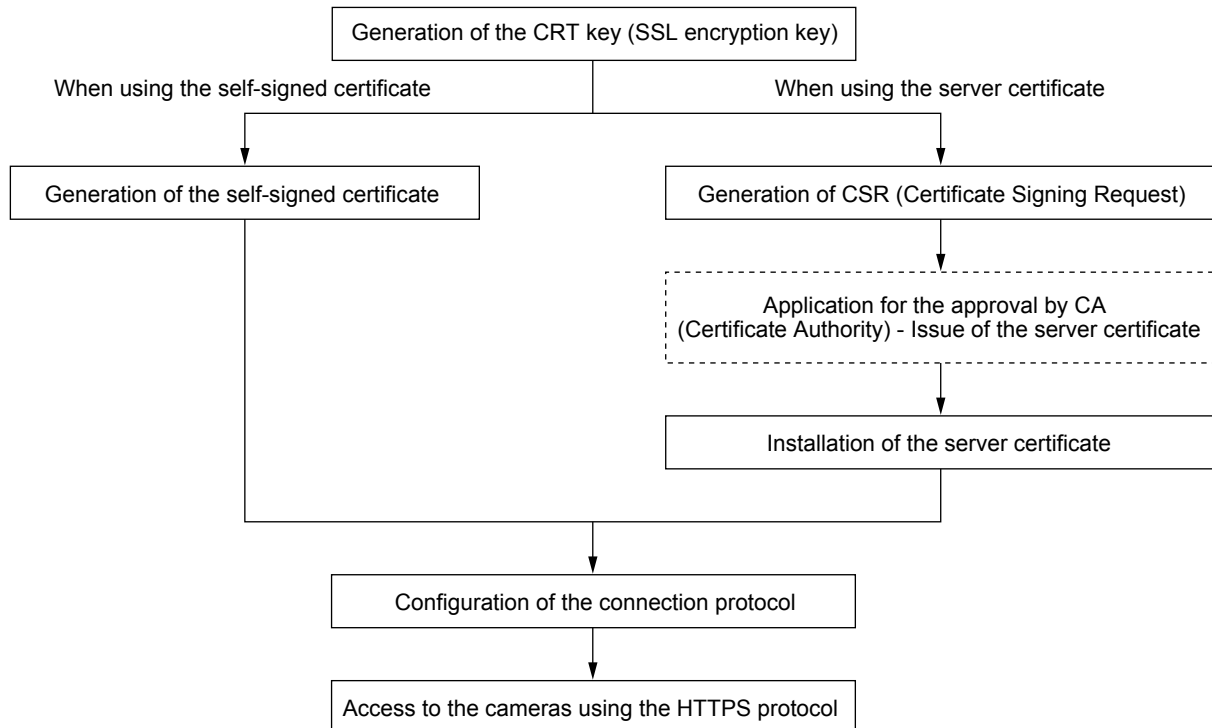

HTTPS	
CRT key generate	<input type="button" value="Execute"/> ①
Self-signed Certificate	Generate <input type="button" value="Execute"/> ②
	Information Not generated <input type="button" value="Confirm"/> <input type="button" value="Delete"/>
CA Certificate	Generate Certificate Signing Request <input type="button" value="Execute"/> ③
	CA Certificate install <input type="text"/> <input type="button" value="Browse..."/> <input type="button" value="Execute"/> ④
	Information Invalid <input type="button" value="Confirm"/> <input type="button" value="Delete"/> ⑤
Connection	HTTP <input type="button" value="Set"/>
HTTPS port	443 (1-65535)

- ① Generation of the CRT key (SSL encryption key) (→page 113)
- ② Generation of the self-signed certificate (→page 114)
- ③ Generation of CSR (Certificate Signing Request) (→page 116)
- ④ Installation of the server certificate (→page 117)
- ⑤ Configuration of the connection protocol (→page 118)

Note

- To use the server certificate, you need to apply for the approval and the issue of server certificate by CA.
- Either of the self-signed certificate or the server certificate is available. If both of them are installed, the server certificate will be used prior to the self-signed certificate.

15.2.1 Generation of the CRT key (SSL encryption key)

IMPORTANT

- When the self-signed certificate or server certificate is valid, it is impossible to generate the CRT key.
- When the server certification is used, the available key size varies depending on the Caches the available key size in advance.
- To generate the CRT key, it may take about 1 minute when the key size is 1024 bit and about 2 minutes when the key size is 2048 bit. Do not operate the web browser until the generation of CRT key is complete. While the CRT key is being generated, the refresh interval and line speed may be lower.

1. Click the [Execute] button of “CRT key generate”.
→ The “CRT key generate” dialog box will be displayed.

Current CRT key		
CRT key	RSA key size	
	Last modified	Not generated

CRT key generate

RSA key size 1024bit 2048bit

*Generating a CRT key takes about 2 minutes.

2. Select “1024bit” or “2048bit” for the length of the CRT to generate for “CRT key generate” - “RSA key size”.

Note

- To use the server certificate, follow the requests from the CA about the RSA key size.

3. Click the [Execute] button.

→ The generation of CRT key will be started. When the generation is finished, the key size and generation time & date of the generated key will be displayed on “Current CRT key”.

Note

- To change (or update) the generated CRT key, perform step 1 to 3. The CRT key, self-signed certificate and server certification are valid in a set. When the CRT key is changed, it is necessary to re-generate the self-signed certificate or re-apply for the server certificate.
- When the CRT key is updated, the log of the previous CRT key is saved. When the [History] button of “Current CRT key” on the “CRT key generate” dialog box is clicked, the “Previous CRT key” dialog box will be displayed, and it is possible to check the key size and generation time & date of the previous

key. When the [Apply] button is clicked on the “Previous CRT key” dialog box, it is possible to replace the current CRT key with the previous one.

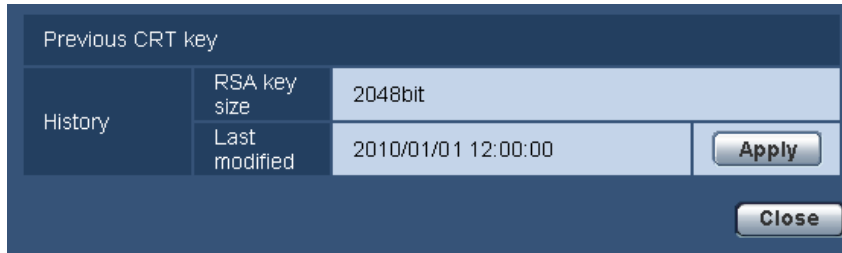

15.2.2 Generation of the self-signed certificate (security certificate)

IMPORTANT

- If the CRT key is not generated, it is impossible to generate the self-signed certificate.
1. Click the [Execute] button of “Self-signed Certificate - Generate”.
→ The “Self-signed Certificate - Generate” dialog box will be displayed.

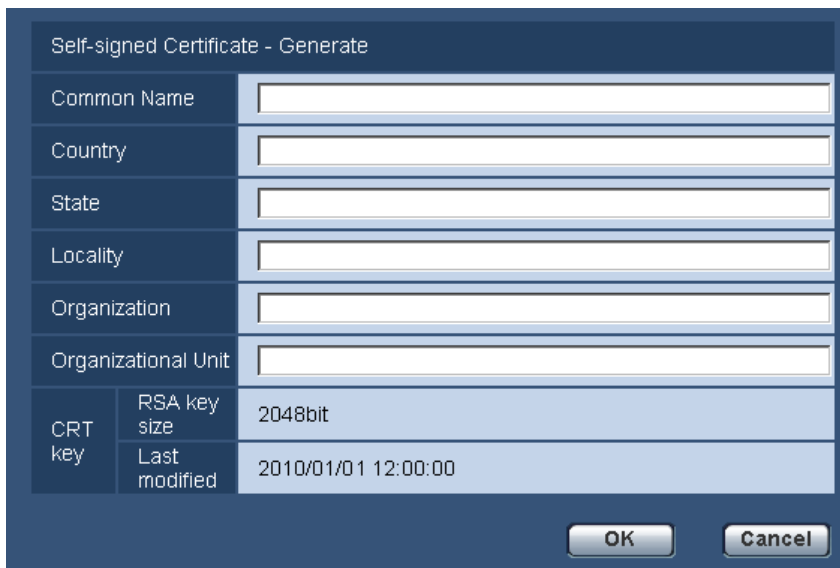

2. Enter the information of the certificate to be generated.

Item	Description	Available number of characters
[Common Name]	Enter the camera address or host name.	64 characters
[Country]	Enter the country name. (Omission is OK.)	2 characters (Country code)
[State]	Enter the state name. (Omission is OK.)	128 characters
[Locality]	Enter the locality name. (Omission is OK.)	128 characters
[Organization]	Enter the organization name. (Omission is OK.)	64 characters

Item	Description	Available number of characters
[Organizational Unit]	Enter the unit name of the organization. (Omission is OK.)	64 characters
[CRT key]	Displays the key size and generation time & date of the current key.	

Note

- The available characters for [Common Name], [State], [Locality], [Organization], [Organizational Unit] are 0-9, A-Z, a-z and the following marks.
- . _ , + / ()
- When the camera is connected to the Internet, enter the address name or host name to access via the Internet for "Common Name". In this case, the security alert window will be displayed each time the camera is locally accessed, even if the security certificate is installed.
- When entering the IPv6 address for "Common Name", put the address in brackets [].
Example: [2001:db8::10]

- Click the [OK] button after entering the items.
→ The self-signed certificate will be generated.

Note

- The information of the generated self-signed certificate will be displayed on "Self-signed Certificate" - "Information".
Depending on the status of the self-signed certificate, the following are displayed.

Indication	Description
Not generated	The self-signed certificate are not generated.
Invalid (Reason: CA Certificate installed)	The self-signed certificate has already been generated, and the server certificate has been installed. <ul style="list-style-type: none"> In this case, the server certificate is validated.
Common name of the self-signed certificate	The self-signed certificate has already been generated and validated.

- When the [Confirm] button is clicked, the registered information of the self-signed certificate (security certificate) will be displayed in the "Self-signed Certificate - Confirm" dialog box.

Self-signed Certificate - Confirm		
Common Name	NWCAM	
Country		
State		
Locality		
Organization		
Organizational Unit		
CRT key	RSA key size	2048bit
	Last modified	2010/01/01 12:00:00
Close		

- When the [Delete] button is clicked, the generated self-signed certificate (security certificate) will be deleted.
- When “HTTPS” is selected for “Connection”, it is impossible to delete the self-signed certificate.

15.2.3 Generation of CSR (Certificate Signing Request)

IMPORTANT

- If the CRT key is not generated, it is impossible to generate the CSR.
 - Before generating the CSR file, configure the following settings on [Internet Options] of the web browser in advance. Click [Internet Options...] under [Tools] of the menu bar of Internet Explorer, and then click the [Security] tab.
 - Register the camera for [Trusted Sites].
 - Click the [Custom Level...] button to open the [Security Setting] window, and check the [Enable] radio button of [File Download] under [Downloads].
 - Click the [Custom Level...] button to open the [Security Setting] window, and check the [Enable] radio button of [Automatic prompting for file downloads] under [Downloads].
1. Click the [Execute] button of “CA Certificate - Generate Certificate Signing Request”.
 → The “CA Certificate - Generate Certificate Signing Request” dialog box will be displayed.

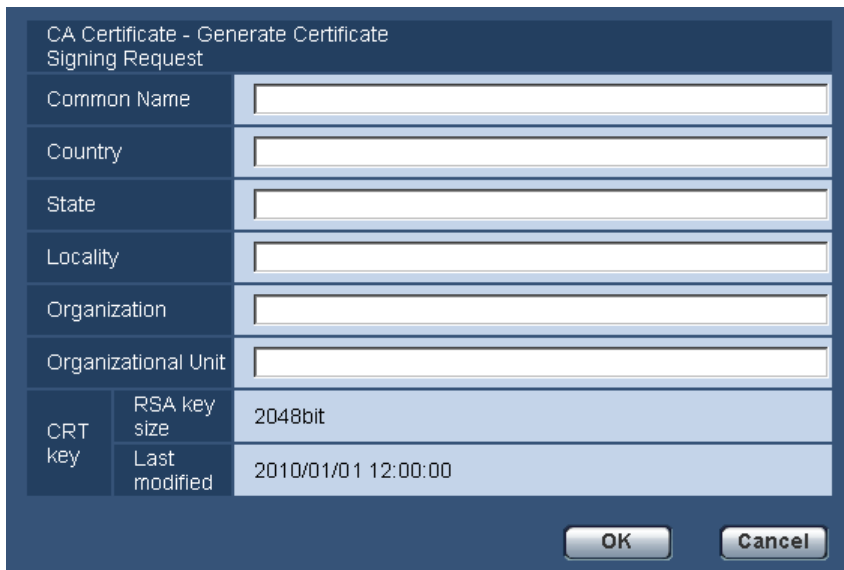

2. Enter the information of the certificate to be generated.

Item	Description	Available number of characters
[Common Name]	Enter the camera address or host name.	64 characters
[Country]	Enter the country name.	2 characters (Country code)
[State]	Enter the state name.	128 characters
[Locality]	Enter the locality name.	128 characters
[Organization]	Enter the organization name.	64 characters
[Organizational Unit]	Enter the unit name of the organization.	64 characters

Item	Description	Available number of characters
[CRT key]	Displays the key size and generation time & date of the current key.	

Note

- To use the server certificate, follow the requests from the CA about the information to be entered.
 - The available characters for [Common Name], [State], [Locality], [Organization], [Organizational Unit] are 0-9, A-Z, a-z and the following marks.
- . _ , + / ()
- Click the [OK] button after entering the items.
→ The [Save As] dialog box will be displayed.
 - Enter a file name for the CSR in the [Save As] dialog box to save on the PC.
→ The saved CSR file will be applied to the CA.

IMPORTANT

- The server certificate will be issued for the set of the generated CSR and CRT key. If the CRT key is re-generated or updated after applying to the CA, the issued server certificate will be invalidated.

Note

- This camera generates the CSR file in the PEM format.

15.2.4 Installation of the server certificate

IMPORTANT

- If the CSR file is not generated, it is impossible to install the server certificate (security certificate). For the installation, the server certificate issued by CA is required.
 - A server certification issued by CA is needed in order to install the server certification.
- Click the [Browse...] button of "CA Certificate - CA Certificate install".
→ The [Open] dialog box will be displayed.
 - Select the server certification file and click the [Open] button. Then, click the [Execute] button.
→ The server certification will be installed.

Note

- The host name registered in the installed server certificate will be displayed on "CA Certificate - Information". Depending on the status of the server certificate, the following are displayed.

Indication	Description
Invalid	The server certification is not installed.
Common name of the server certificate	The server certificate has already been installed and validated.
Expired	The server certification has already expired.

15 Configuring the network settings [Network]

- When the [Confirm] button is clicked, the registered information of the installed server certificate will be displayed in the “CA Certificate - Confirm” dialog box. (Only “Organizational Unit” will be displayed with an asterisk (*).)

CA Certificate - Confirm		
Common Name	NWCAM	
Country	JP	
State	Kanagawa	
Locality	Yokohama	
Organization	Panasonic	
Organizational Unit	Group	
CRT key	RSA key size	2048bit
	Last modified	2010/01/01 12:00:00

- When the [Delete] button is clicked, the installed server certificate will be deleted.
- When “HTTPS” is selected for “Connection”, it is impossible to delete the server certificate.
- To change (or update) the server certificate, perform step 1 and 2.

IMPORTANT

- Before deleting the valid server certificate (security certificate), confirm that there is a backup file on the PC or another media. The backup file will be required when installing the server certificate again.
- When the server certificate has expired, the HTTPS function will become unavailable. When the camera is restarted, the connection protocol will be changed to HTTP. Update the server certificate before it expires.
- The expiration date of the server certificate can be checked by double-clicking the server certification file issued by CA.

15.2.5 Configuration of the connection protocol

1. Select “HTTP” or “HTTPS” for “Connection” to determine the protocol used to access the camera.
 - **HTTP:** Only the HTTP connection is available.
 - **HTTPS:** Only the HTTPS connection is available.

2. Designate the HTTPS port number to be used for “HTTPS port”.

- **Available port number:** 1 - 65535
- **Default:** 443

The following port numbers are unavailable since they are already in use.

20, 21, 23, 25, 42, 53, 67, 68, 69, 80, 110, 123, 161, 162, 554, 995, 10669, 10670, 59000 - 61000

3. Click the [Set] button.

→ The camera will restart, and it will become possible to access to the cameras using the HTTPS protocol. (→page 7, page 19, page 22)

Note

- The camera will restart after the connection setting is changed.
- **When using the self-signed certificate:**
If the camera is accessed using the HTTPS protocol for the first time, the warning window will be displayed. In this case, follow the instructions of the wizard to install the self-signed certificate. (→page 119)
- **When using the server certificate:**

In advance, install the root certificate and intermediate certificate on the browser in use. Follow the instructions of CA for how to obtain and install these certificates.

- When the camera is accessed using the HTTPS protocol, the refresh interval and frame rate of images may be lower.
- When the camera is accessed using the HTTPS protocol, it may take time to display images.
- When the camera is accessed using the HTTPS protocol, the images may be distorted or audio may be interrupted.
- When the camera is accessed using the HTTPS protocol, the number of users that can access the camera may be reduced. The maximum number of concurrent access user varies depending on the maximum image size and transmission format.

15.3 Access the camera using the HTTPS protocol

1. Start up the web browser.
2. Enter the IP address of the camera in the address box of the browser.
 - **Example of entry:** https://192.168.0.10/

IMPORTANT

- When the HTTPS port number is changed from “443”, enter “https://IP address of the camera + : (colon) + port number” in the address box of the browser.
(**Example:** https://192.168.0.11:61443)
 - When the camera is in a local network, configure the proxy server setting of the web browser (under [Internet Options...] under [Tools] of the menu bar) to bypass the proxy server for the local address.
3. Press the [Enter] key on the keyboard.
 - The “Live” page will be displayed.
 - When the security alert window is displayed, install the security certificate. (→page 120 - page 126)
 - When “On” is selected for “User auth.”, the authentication window will be displayed before displaying live images for the user name and password entries.

IMPORTANT

- When the camera is accessed using the HTTPS protocol, the refresh interval and frame rate of images may be lower.

15.3.1 Install the security certificate

When the security certificate of the camera to access is not installed on the PC, the security alert window will be displayed each time the camera is accessed using the HTTPS protocol. To have the security alert window not displayed, it is necessary to install the security certificate in the following procedure. If the certificate is not installed, the alert window will be displayed each time the camera is accessed.

Note

- The security certificate is installed on the PC with the information registered for “Common Name”. Therefore, the information registered for “Common Name” must be same as the address or host name for the camera access. If the certificate is not the same, the security alert window will be displayed each time the camera is accessed.
- When the address or host name of the camera is changed, the security alert window will be displayed each time the camera is accessed even if the security certificate is installed. Install the security certificate again.

15 Configuring the network settings [Network]

- When the camera access is open to the Internet, enter the address name or host name to access via the Internet for “Common Name”. In this case, the security alert window will be displayed each time the camera is locally accessed, even if the security certificate is installed.
- When the security certificate is properly installed, a key icon is displayed in the address box of the web browser that has accessed the camera. (When using Internet Explorer 7, Internet Explorer 8, or Internet Explorer 9)

When using Internet Explorer 7, Internet Explorer 8, or Internet Explorer 9

When using Internet Explorer 7 or Internet Explorer 8 with Windows XP, note that some of the displayed windows may differ from the following descriptions.

1. Access the camera using the HTTPS protocol.
2. When the security alert window is displayed, click “Continue to this website (not recommended).”

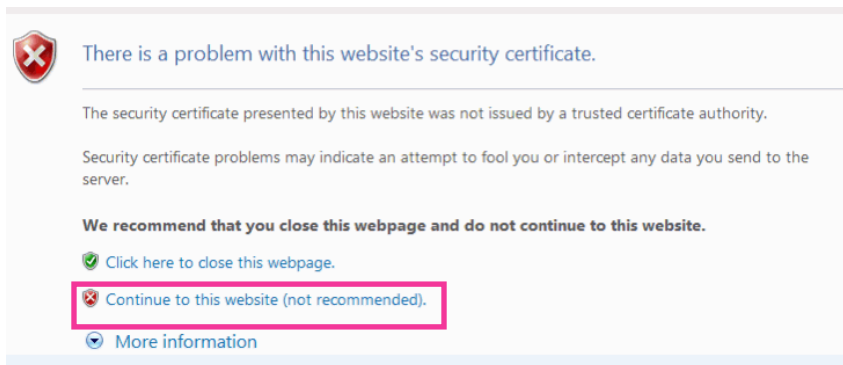

→ Enter the user name and password. The “Live” page will be displayed.

Note

- If this window is displayed when accessing a device other than the camera or a website, a security problem may have occurred. In this case, check the system status.

3. Click “Certificate Error” over the URL, and click “View certificates”.

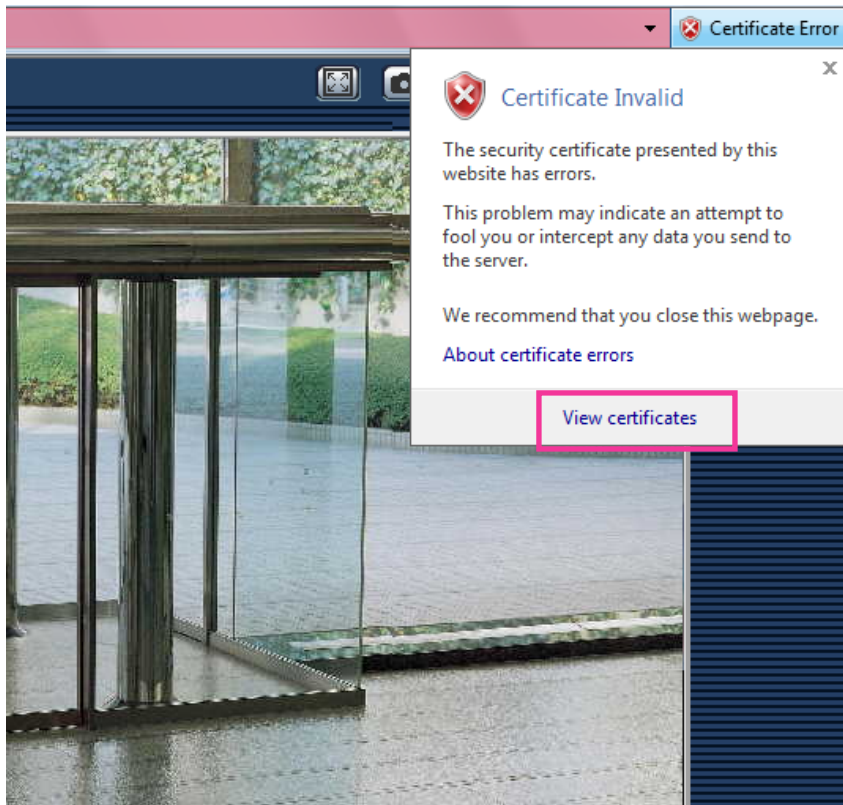

4. Click “Install Certificate...”.

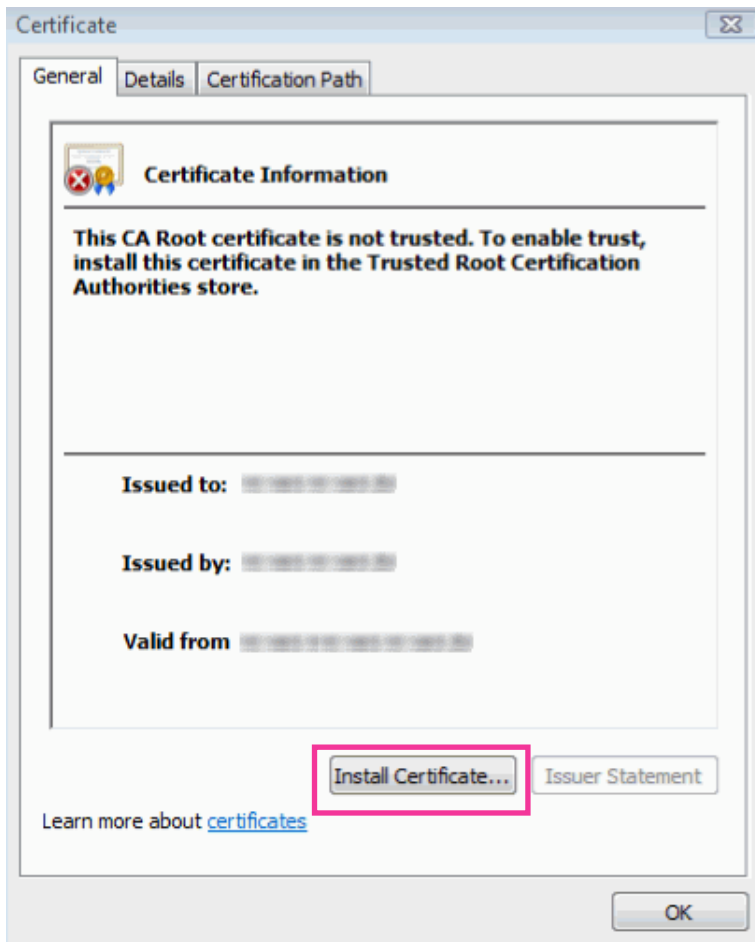

Note

- If [Install Certificate...] is not displayed, close Internet Explorer once, and select [Run as Administrator] to launch Internet Explorer again. Click [Start] → [All Programs] → right click [Internet Explorer] → click [Run as Administrator].

5. Click “Next” displayed on “Certificate Import Wizard”.

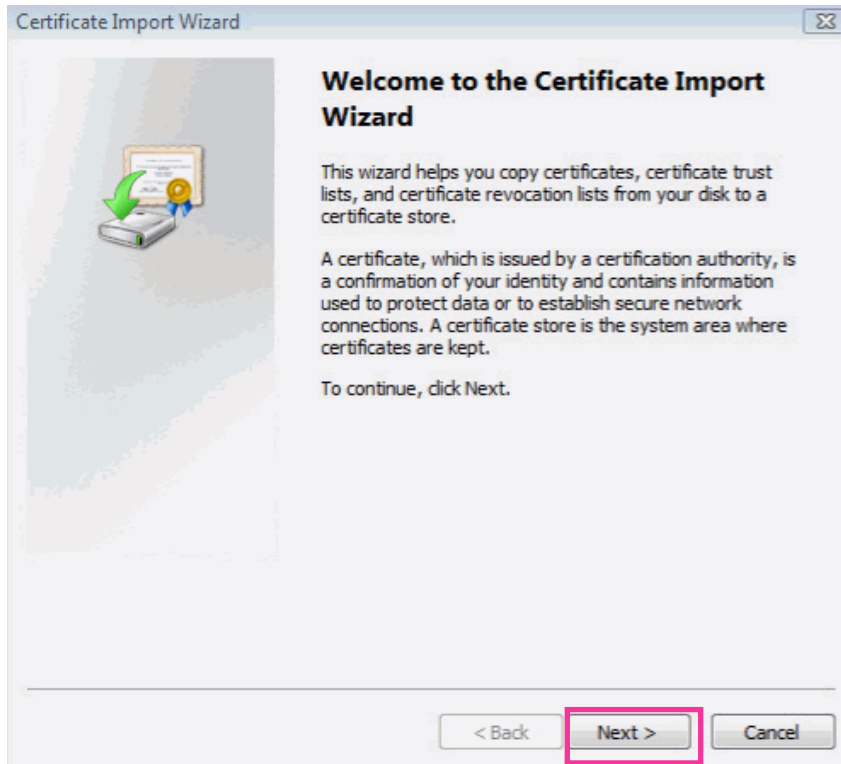

6. Select “Place all certificates in the following store”, and click “Browse...”.

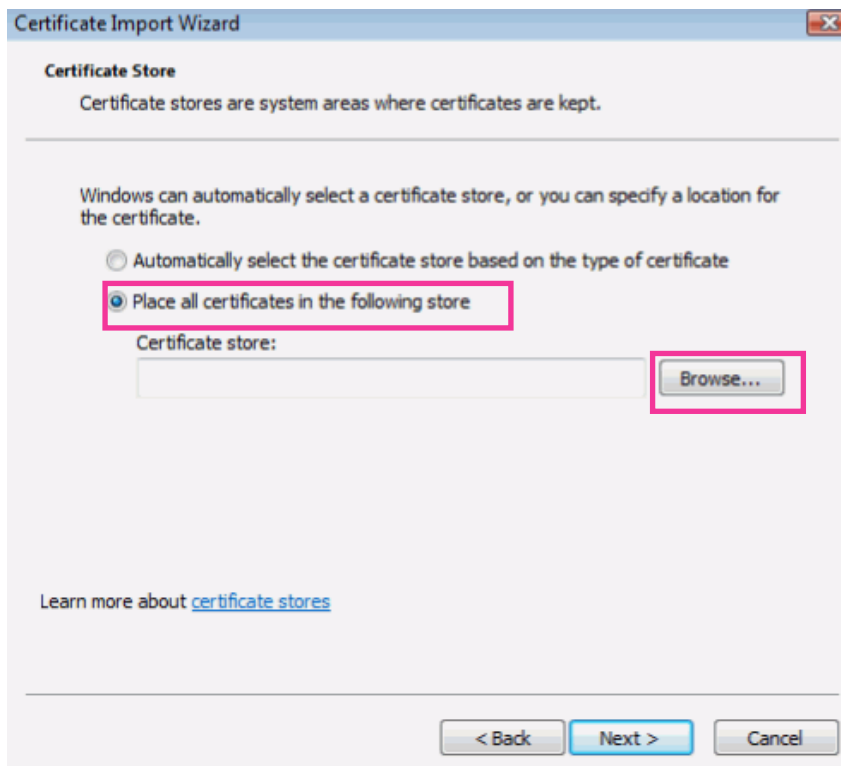

15 Configuring the network settings [Network]

7. Select “Trusted Root Certificate Authorities”, and click “OK”.

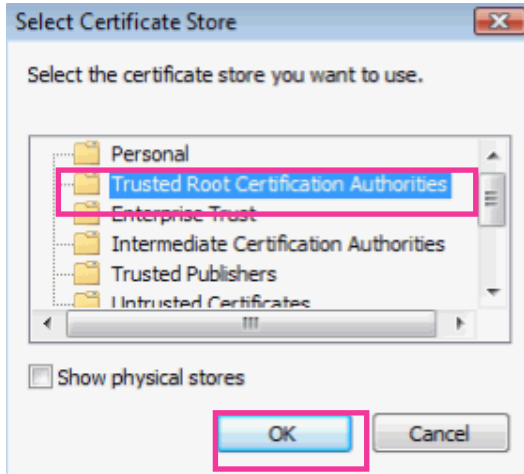

8. Click “Next”.

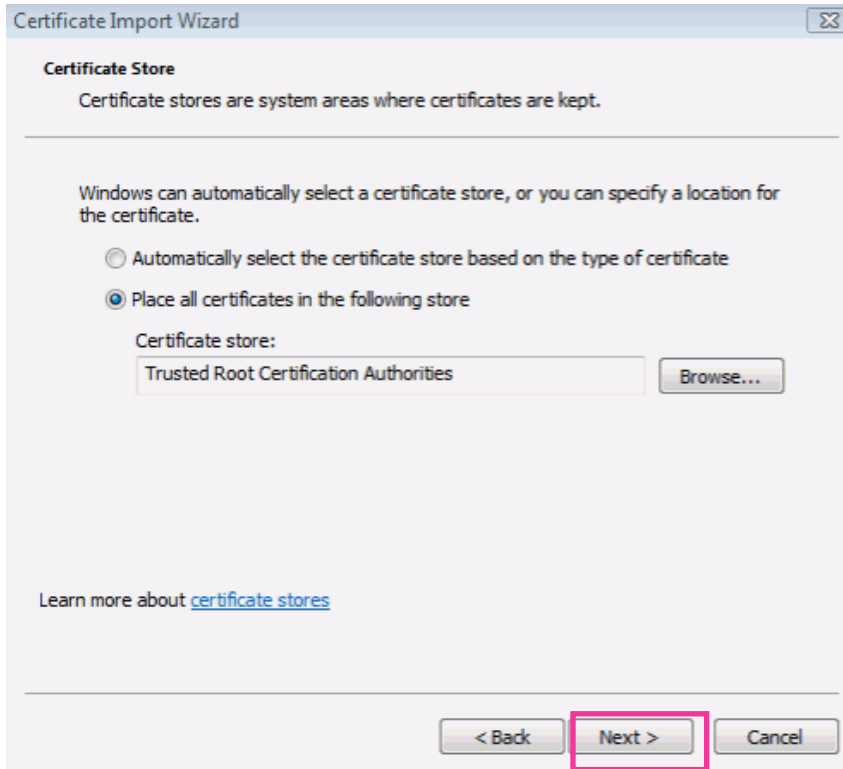

9. Click "Finish".

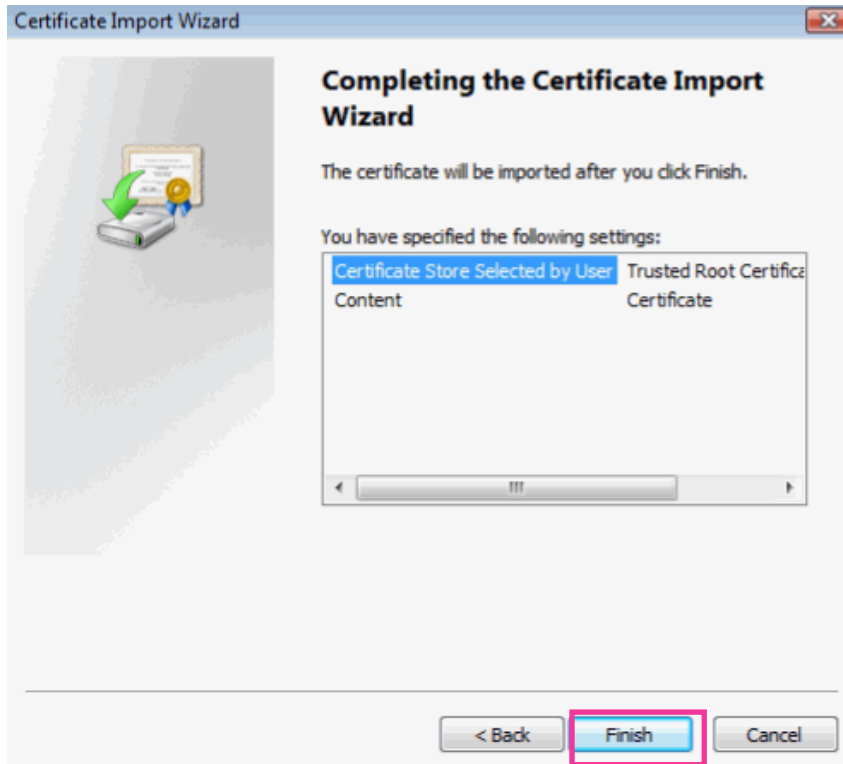

10. Click "Yes".

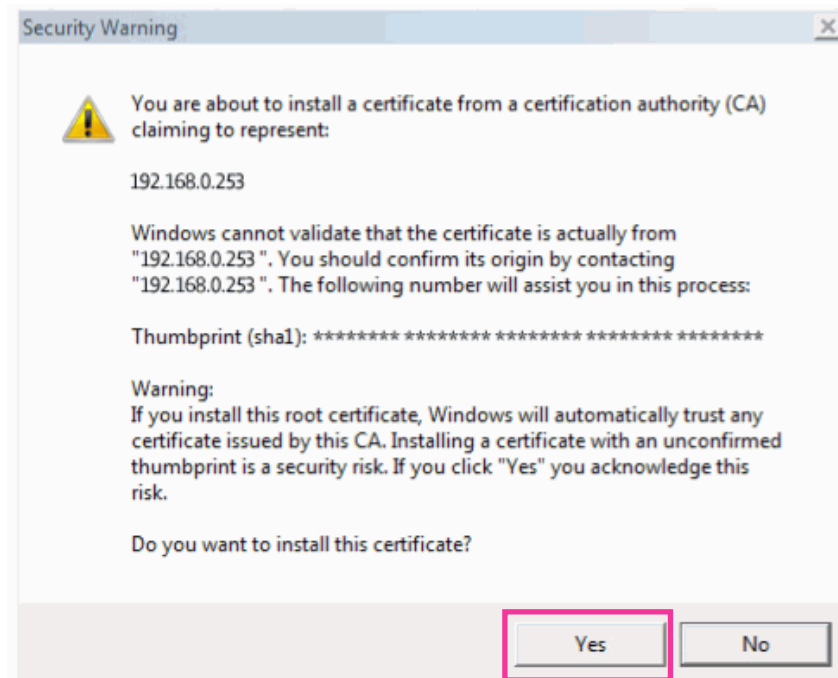

→ When the import is successfully completed, the screen "The import was successful." will be displayed.

11. Click "OK".

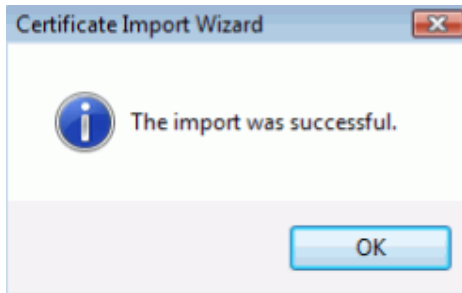

→ When the browser is restarted after the certificate is imported, "Certificate Error" will not be displayed.

OS: Windows XP, Web browser: When using Internet Explorer 6

1. Access the camera using the HTTPS protocol.
2. Click "View Certificate".



Note

- If this window is displayed when accessing a device other than the camera or a website, a security problem may have occurred. In this case, check the system status.

3. Click “Install Certificate...”.

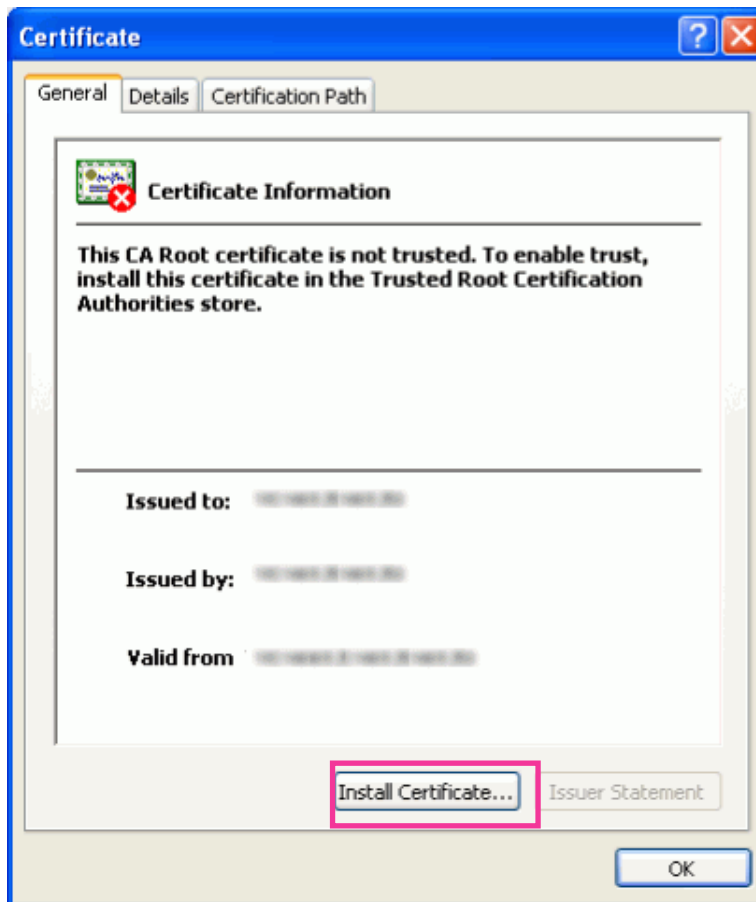

4. Click “Next >” according to the procedures displayed on the displayed on “Certificate Import Wizard”.

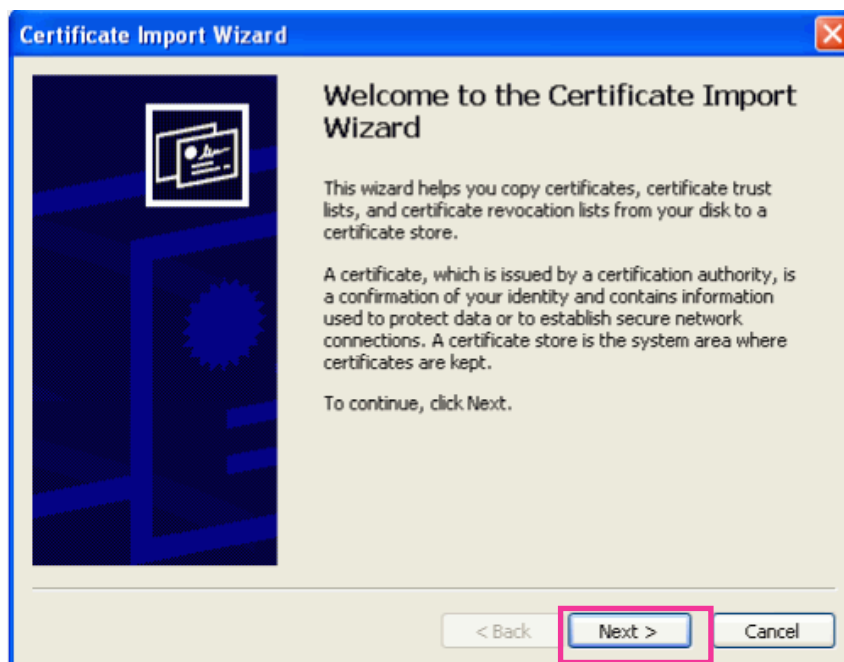

15 Configuring the network settings [Network]

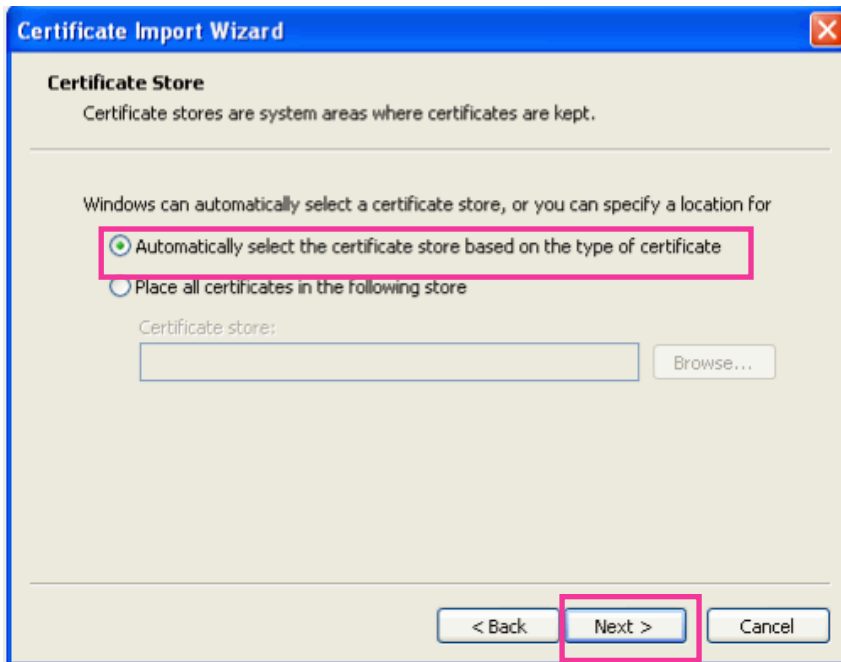

- 5. Click "Finish".

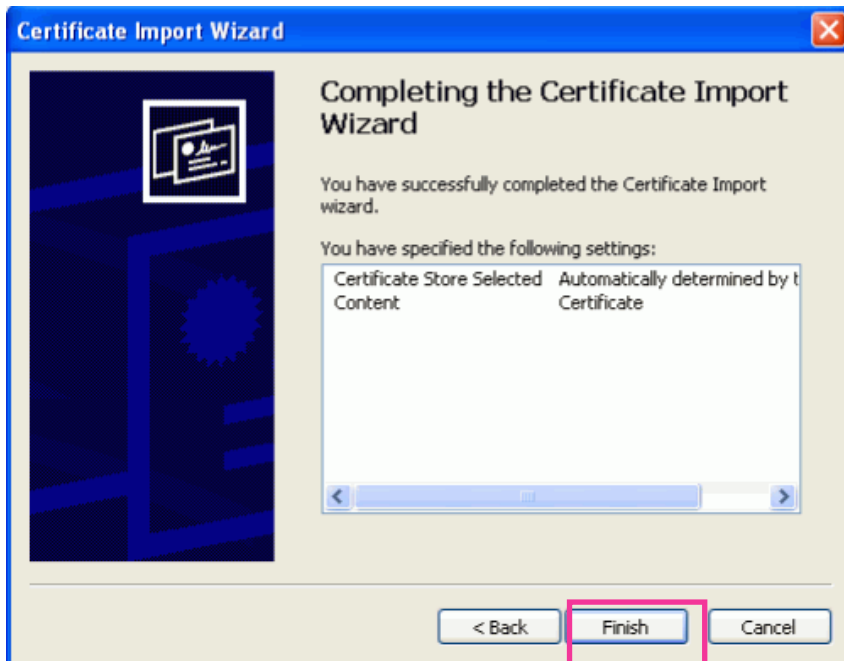

6. When the security alert window is displayed, click “Yes”.

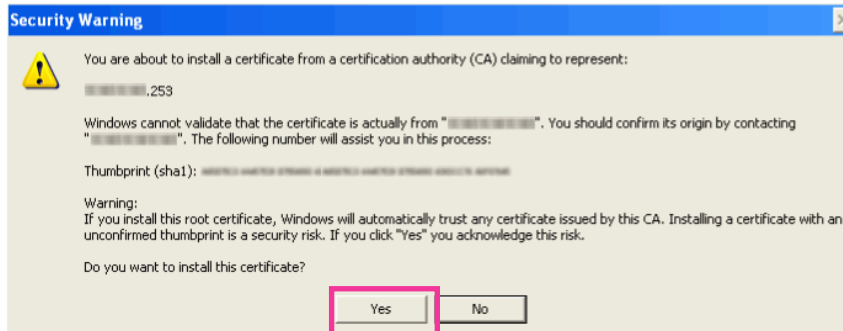

→ When the import is successfully completed, the screen “The import was successful.” will be displayed.

7. Click “OK”.



→ When the browser is restarted after the certificate is imported, “Certificate Error” will not be displayed.

15.4 Configure the settings relating to DDNS [DDNS]

Click the [DDNS] tab on the “Network” page. (→page 34, page 35)

To access this camera via the Internet, it is necessary to configure the settings for the DDNS function.

When activating the DDNS function using the camera, either of the following DDNS services is available.

- “Viewnetcam.com” service
- Dynamic DNS Update (RFC2136 compliant)

IMPORTANT

- Before using the DDNS service, it is necessary to perform the port forwarding setting for the router.
- **About Dynamic DNS Update (RFC2136 compliant)**
Operation using DDNS services other than the “Viewnetcam.com” service is not guaranteed. We are not responsible for any troubles or accidents on the circumstances where the camera is used arising out of such services.
Refer to the DDNS service providers for the selection and configuration of the DDNS services other than the “Viewnetcam.com” service.

Note

- “Viewnetcam.com” is a Dynamic DNS service designed for use with Panasonic Network Cameras. Refer to the “Viewnetcam.com” website (<http://www.viewnetcam.com/>) for further information about the service.

About DDNS services (IPv4/IPv6)

By using a DDNS service, it becomes possible to view camera images via the Internet.

The DDNS service associates dynamic global addresses and domain names.

It is possible to configure the settings for the “Viewnetcam.com” or Dynamic DNS Update (RFC2136 compliant). In most of the DNS services offered by providers, global addresses are not static but dynamic. Therefore, access to the camera via an old global address may be invalidated after a certain period of time. Either of the following services is required when accessing a camera whose global address is not static via the Internet.

- **DDNS service (such as “Viewnetcam.com”)**

It is possible to access via a registered and static domain name (example: *****.viewnetcam.com) even after the global address is changed. Enrollment in a domain name service is required even when using the IPv6 connection.

Refer to the “Viewnetcam.com” website (<http://www.viewnetcam.com/>) for further information about the service.

- **Static IP address service (such as a service offered by a contracted provider)**

In this service, global addresses are static (not changed).

15.4.1 Configuration of the DDNS service (Example of the “Viewnetcam.com” service)

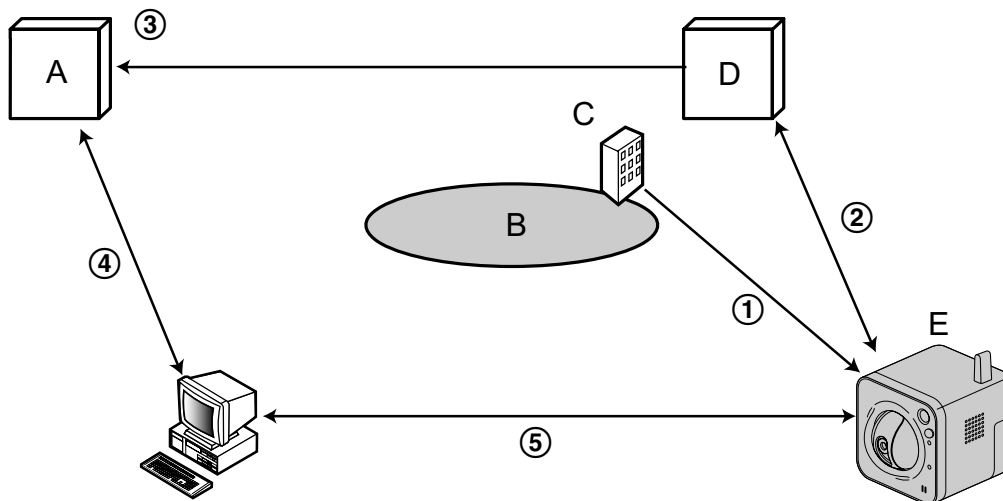

- A. DNS server
- B. Internet
- C. Provider
- D. “Viewnetcam.com” service server
- E. Remote site

① **Global address is changed.**

The contracted provider allocates a global address to the router (or the camera). The global address is not static but dynamic.

② **“*****.viewnetcam.com” and the current global address is automatically registered.**

If you are enrolled in “Viewnetcam.com”, the unique “domain name” (example: *****.viewnetcam.com) will be allocated. The “Viewnetcam.com” service server automatically manages the domain name of camera and the global address of router (or camera) when a camera automatically notifies the service server of the global address.

③ **Current global address is automatically registered via “*****.viewnetcam.com”.**

The “Viewnetcam.com” service server registers the global address and the domain name of router (or camera) in the DNS server.

④ **Global address is obtained via the URL (domain name).**

By entering the URL (including the domain name) on the web browser when accessing the camera via the Internet, the DNS server identifies the registered global address of router (or camera).

⑤ **Access using the current global address**

The identified global address is used for accessing the router (or camera) to monitor images.

Note

- Refer to the contracted provider whether the current IP address is static or not.
- Depending on the provider, local addresses may be allocated. In this case, the DDNS service is unavailable. Refer to the contract provider for further information.

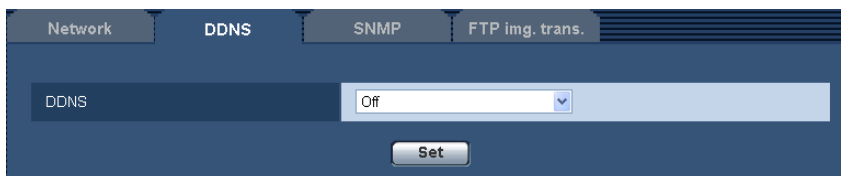

[DDNS]

Select the DDNS service to determine whether or not to use DDNS.

- **Off:** Does not use the DDNS function.
- **Viewnetcam.com:** Uses the “Viewnetcam.com” service.
- **Dynamic DNS Update:** Uses Dynamic DNS Update (RFC2136 compliant) without the DHCP cooperation.
- **Dynamic DNS Update(DHCP):** Uses Dynamic DNS Update (RFC2136 compliant) with the DHCP cooperation.
- **Default:** Off

Note

- When using Dynamic DNS Update (RFC2136 compliant), refer to the network administrator for whether or not to cooperate with the DHCP.

15.4.2 When using the “Viewnetcam.com” service

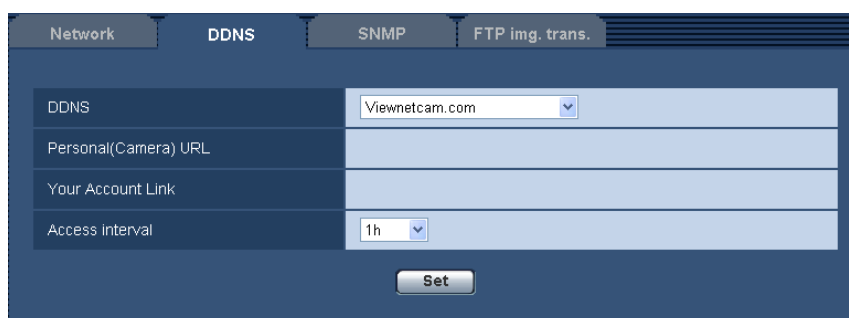

[Personal(Camera) URL]

The URL of the camera registered for “Viewnetcam.com”.

[Your Account Link]

When the displayed URL is clicked, the registration window for the “Viewnetcam.com” service will be displayed in a newly opened window.

Register the information in the registration window to enroll in the “Viewnetcam.com” service.

[Access interval]

Select the interval to access the “Viewnetcam.com” service server to check the IP address and the host name from the following.

10min/ 20min/ 30min/ 40min/ 50min/ 1h

- **Default:** 1h

15.4.3 Procedure to register information for the “Viewnetcam.com” service

1. Select [Viewnetcam.com] for [DDNS] and click the [Set] button.
→ A URL is displayed in [Your Account Link].
If a URL is not displayed in [Your Account Link], confirm the camera's network settings and Internet connection, then click [Set] again.
2. Click the URL displayed in [Your Account Link].

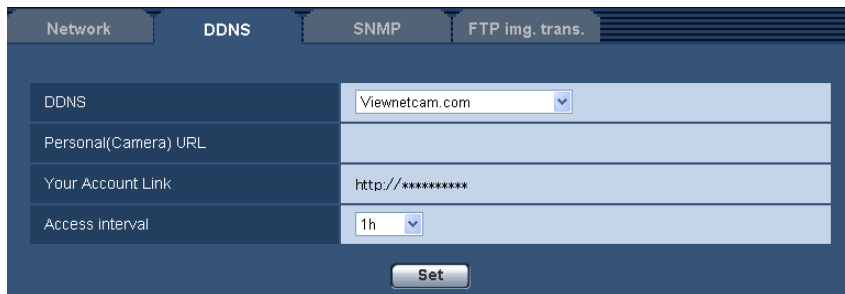

→ The registration window for “Viewnetcam.com” will be displayed in a newly opened window. When the registration window is not displayed, check that the PC is being connected to the Internet, and click the reload button of the browser.

3. Register the information for “Viewnetcam.com” by following the instructions of the wizard.
→ When the message “The new camera is successfully registered to Viewnetcam.com” is displayed, close the registration window.
The URL set at the time of registration can be used for camera access. However, this URL is unavailable when accessing the camera from the PC connected to the same network (LAN).

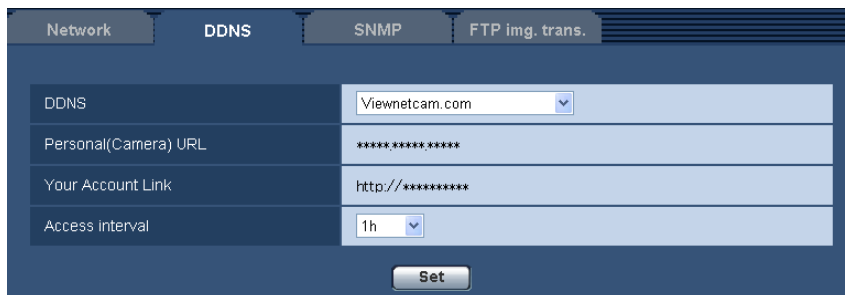

Note

- When the registration for the “Viewnetcam.com” service is completed, the URL registered for “Personal(Camera) URL” is displayed. It may take up to about 30 minutes until the URL of the registered camera is validated.
- To cancel the enrollment in the “Viewnetcam.com” service, access the “Viewnetcam.com” website (<http://www.viewnetcam.com/>) later.

- When “Expired” is displayed in the URL of “Viewnetcam.com” in the viewnetcam settings page or the status page, restart the camera after registering the “Viewnetcam.com” service. After restarting the camera, check that the registered URL is displayed in the URL of “Viewnetcam.com” of [Status] - [Viewnetcam.com] on the “Maintenance” page.
- It is possible to check the information registered for the “Viewnetcam.com” service by accessing the URL displayed beside “Your Account Link”. When the URL is not displayed, check that the PC is being connected to the Internet, and click the [Set] button.
- If access often fails due to the change in the global address of router, set a smaller value for “Access interval”.

15.4.4 Checking the information registered for the “Viewnetcam.com” service

It is possible to check if the camera has been registered for the “Viewnetcam.com” service. (→page 156)

15.4.5 When using “Dynamic DNS Update”

[Host name]

Enter the host name to be used for the Dynamic DNS Update service.

- **Available number of characters:** 3 - 250 characters
Enter in the form of “(host name). (domain name)”.
- **Available characters:** Alphanumeric characters, the colon (:), the period (.), the underscore (_), and the hyphen (-).
- **Default:** None (blank)

Note

- Refer to the network administrator for further information about the available host names.

[Access interval]

Select the interval to access the Dynamic DNS Update service server to check the IP address and the host name from the following.

10min/ 20min/ 30min/ 40min/ 50min/ 1h/ 6h/ 24h

- **Default:** 24h

15.4.6 When using “Dynamic DNS Update(DHCP)”

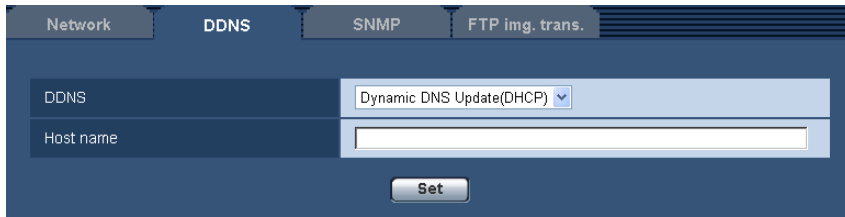

[Host name]

Enter the host name to be used for the Dynamic DNS Update service.

- **Available number of characters:** 3 - 250 characters
Enter in the form of “(host name). (domain name)”.
- **Available characters:** Alphanumeric characters, the colon (:), the period (.), the underscore (_), and the hyphen (-).
- **Default:** None (blank)

Note

- Refer to the network administrator for further information about the available host names.

15.5 Configure the settings relating to SNMP [SNMP]

Click the [SNMP] tab on the “Network” page. (→page 34, page 35)

The settings relating to SNMP can be configured on this page. It is possible to check the status of the camera by connecting to the SNMP manager. When using the SNMP function, contact the network administrator.

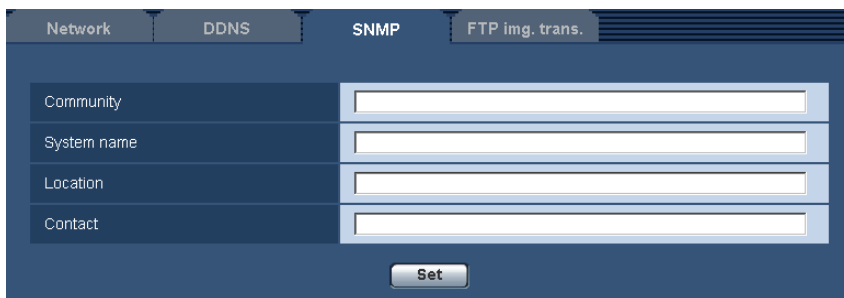

[Community]

Enter the community name to be monitored.

- **Available number of characters:** 0 - 32 characters
- **Default:** None (blank)

IMPORTANT

- When using the SNMP function, it is necessary to enter the community name. When no community name is entered, the SNMP function will not work.

[System name]

Enter a system name to be used to manage the camera with the SNMP function.

- **Available number of characters:** 0 - 32 characters
- **Default:** None (blank)

[Location]

Enter the name of the location where the camera is installed.

- **Available number of characters:** 0 - 32 characters
- **Default:** None (blank)

[Contact]

Enter the E-mail address or the phone number of the SNMP manager.

- **Available number of characters:** 0 - 255 characters
- **Default:** None (blank)

15.6 Configure the settings relating to the FTP periodic image transmission [FTP img. trans.]

Click the [FTP img. trans.] tab on the “Network” page. (→page 34, page 35)

The settings relating to the periodic transmission of images to an FTP server can be configured on this page. To transmit images to an FTP server periodically, it is necessary to configure the settings of the FTP server in advance (→page 100). Refer to page 137 for descriptions of how to configure schedules of image transmission.

IMPORTANT

- Depending on the network line speed or the network traffic, images may not be transmitted at the exact designated interval or period.
- When “On” is selected for both of the alarm image transmission function and the FTP periodic image transmission function, the alarm image transmission function will be given priority over the FTP periodic image transmission function. For this reason, images may not be transmitted at the exact designated interval or period if alarms occur frequently.

Network	DDNS	SNMP	FTP img. trans.
FTP periodic image transmission			FTP >>
FTP periodic image transmission		<input type="radio"/> On <input checked="" type="radio"/> Off	
Directory name		<input type="text"/>	
File name		<input type="text"/> <input checked="" type="radio"/> Name w/time&date <input type="radio"/> Name w/o time&date	
Transmission interval		1s	
Image capture size		640x360	
<input type="button" value="Set"/>			

FTP periodic image transmission

[FTP >>]

When “FTP >>” is clicked, the [FTP] tab of the “Server” page will be displayed. (→page 100)

[FTP periodic image transmission]

Select “On” or “Off” to determine whether or not to transmit images using the FTP periodic image transmission function.

When “On” is selected, it is necessary to configure the settings of the FTP server. (→page 100)

- **Default:** Off

[Directory name]

Enter the directory name where the images are to be saved.

For example, enter “/img” to designate the directory “img” under the root directory of the FTP server.

- **Available number of characters:** 1 - 256 characters
- **Unavailable characters:** " & ;
- **Default:** None (blank)

[File name]

Enter the file name (name of the image file to be transmitted) and select the naming option from the following.

- **Name w/time&date:** File name will be [“Entered file name” + “Time and date (year/ month/ day/ hour/ minute/ second)” + “Serial number (starting from 00)”].
- **Name w/o time&date:** File name will be the characters entered for “File name” only. When “Name w/o time&date” is selected, the file will be overwritten each time a file is newly transmitted.
- **Available number of characters:** 1 - 32 characters
- **Unavailable characters:** " & ; : / * < > ? \ |
- **Default:** None (blank)

Note

- When “Name w/time&date” is selected, the file name will be [“Entered file name” + “Time and date (year/ month/ day/ hour/ minute/ second)” + “Serial number (starting from 00)”] + “s” during summer time.

[Transmission interval]

Select the interval for the FTP periodic image transmission from the following.

1s/ 2s/ 3s/ 4s/ 5s/ 6s/ 10s/ 15s/ 20s/ 30s/ 1min/ 2min/ 3min/ 4min/ 5min/ 6min/ 10min/ 15min/ 20min/ 30min/ 1h/ 1.5h/ 2h/ 3h/ 4h/ 6h/ 12h/ 24h

- **Default:** 1s

[Image capture size]

Select the capture size of images to be transmitted from the following.

When “4:3” is selected for “Aspect ratio”

VT164W VT164 VP104W VP104 :

QVGA/ VGA/ 800x600

VP101 :

QVGA/ VGA

When “16:9” is selected for “Aspect ratio”

VT164W VT164 VP104W VP104 :

320x180/ 640x360/ 1280x720

VP101 :

320x180/ 640x360

- **Default:** 640x360 VT164W VT164 VP104W VP104 /VGA VP101

15.7 Configure the schedule settings of the FTP periodic image transmission [FTP img. trans.]

Click the [FTP img. trans.] tab on the “Network” page. (→page 34, page 35)

The schedule settings of the FTP periodic image transmission can be configured in this section. Refer to page 135 for further information about the settings relating to the FTP periodic image transmission.

15.7.1 How to set the schedules

FTP image transmission schedule

Schedule 1

Mon Tue Wed Thu Fri Sat Sun

24h 00 : 00 - 00 : 00

Schedule 2

Mon Tue Wed Thu Fri Sat Sun

24h 00 : 00 - 00 : 00

Schedule 3

Mon Tue Wed Thu Fri Sat Sun

24h 00 : 00 - 00 : 00

Set

	0:00	6:00	12:00	18:00	24:00
Mon					
Tue					
Wed					
Thu					
Fri					
Sat					
Sun					

1. Check the check box of the desired day of the week of “FTP image transmission schedule”.
→ The selected day of the week will be validated for the schedule.
2. To designate time, select the desired “hour” and “minute” from the pull-down menu.
When not designating time, check the checkbox of “24h”.

15 Configuring the network settings [Network]

3. Click the [Set] button after completing the settings.
→ The result will be displayed at the bottom of the window.

FTP image transmission schedule

Schedule	Days	Start Time	End Time
Schedule 1	Mon, Tue, Wed, Thu, Fri	09:00	17:30
Schedule 2	Mon, Tue, Wed, Thu, Fri, Sat, Sun	23:00	07:00
Schedule 3	Sat, Sun	00:00	00:00

Set

Day	0:00	6:00	12:00	18:00	24:00
Mon	Green	Green	Green	Green	Green
Tue	Green	Green	Green	Green	Green
Wed	Green	Green	Green	Green	Green
Thu	Green	Green	Green	Green	Green
Fri	Green	Green	Green	Green	Green
Sat	Green	Green	Green	Green	Green
Sun	Green	Green	Green	Green	Green

15.7.2 How to delete the set schedule

FTP image transmission schedule

Schedule	Days	Start Time	End Time
Schedule 1	Mon, Tue, Wed, Thu, Fri	09:00	17:30
Schedule 2	Mon, Tue, Wed, Thu, Fri, Sat, Sun	23:00	07:00
Schedule 3	Sat, Sun	00:00	00:00

Set

Day	0:00	6:00	12:00	18:00	24:00
Mon	Green	Green	Green	Green	Green
Tue	Green	Green	Green	Green	Green
Wed	Green	Green	Green	Green	Green
Thu	Green	Green	Green	Green	Green
Fri	Green	Green	Green	Green	Green
Sat	Green	Green	Green	Green	Green
Sun	Green	Green	Green	Green	Green

1. Uncheck the check box of the set day of the week.

2. Click the [Set] button after completing the settings.
→ The schedule of the selected day of the week is deleted.

FTP image transmission schedule

Schedule 1	<input type="checkbox"/> Mon <input type="checkbox"/> Tue <input type="checkbox"/> Wed <input type="checkbox"/> Thu <input type="checkbox"/> Fri <input type="checkbox"/> Sat <input type="checkbox"/> Sun <input type="checkbox"/> 24h <input type="text" value="00"/> : <input type="text" value="00"/> - <input type="text" value="00"/> : <input type="text" value="00"/>
Schedule 2	<input type="checkbox"/> Mon <input type="checkbox"/> Tue <input type="checkbox"/> Wed <input type="checkbox"/> Thu <input type="checkbox"/> Fri <input type="checkbox"/> Sat <input type="checkbox"/> Sun <input type="checkbox"/> 24h <input type="text" value="00"/> : <input type="text" value="00"/> - <input type="text" value="00"/> : <input type="text" value="00"/>
Schedule 3	<input type="checkbox"/> Mon <input type="checkbox"/> Tue <input type="checkbox"/> Wed <input type="checkbox"/> Thu <input type="checkbox"/> Fri <input type="checkbox"/> Sat <input type="checkbox"/> Sun <input type="checkbox"/> 24h <input type="text" value="00"/> : <input type="text" value="00"/> - <input type="text" value="00"/> : <input type="text" value="00"/>

	0:00	6:00	12:00	18:00	24:00
Mon					
Tue					
Wed					
Thu					
Fri					
Sat					
Sun					

16 Use the camera on a wireless LAN [Wireless] (BL-VT164W/BL-VP104W)

Wireless network settings for connecting the camera to a wireless router or other wireless device can be configured on the “Wireless” page.

The “Wireless” page has 2 tabs; the [Basic] tab and the [Status] tab.

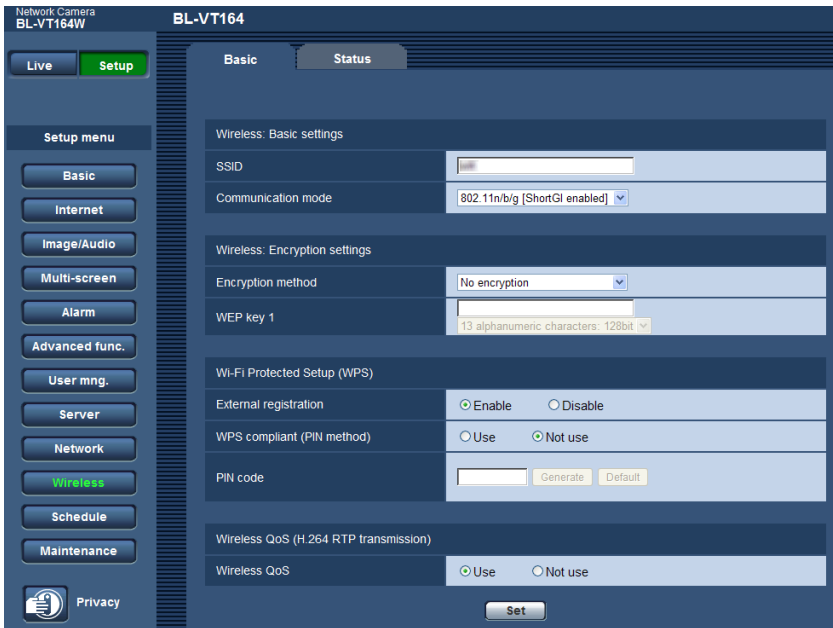

Complete the network settings with a wired connection using a LAN cable before performing wireless settings. (→page 104)

If the wireless router supports automatic settings using WPS, perform settings automatically. (→page 144)

If the wireless router does not support automatic settings using WPS, perform settings manually. (→page 140)

The camera's “Wireless QoS” function can be used. (→page 148)

After completing the camera's wireless settings, information such as the wireless connection status and wireless information can be checked. (→page 148)

16.1 Manually connecting the camera to a wireless LAN (manual settings) [Basic]

Click the [Basic] tab on the “Wireless” page. (→page 34, page 35)

The wireless settings can be manually configured to the camera in this section, and the camera can be connected to the wireless network.

1. Check the wireless router's setting information.
 - Check the SSID and wireless security settings configured to your wireless router, and whether MAC address filtering is activated or deactivated.
 - If MAC address filtering is activated, register the camera's MAC address to the wireless router. You can check the camera's MAC address from the sticker attached to the camera or from the MAC address displayed in "Mac address of the wireless module" (→page 148).
2. Set each item of [Wireless: Basic settings].

[SSID]

Enter the SSID (network identification name). The SSID must be entered. (SSID is also called ESSID.)

- **Available number of characters:** 1 - 32 characters
- **Available characters:** Alphanumeric characters and spaces.
Entries are case sensitive.
- **Default:** wifi

[Communication mode]

Select the same communications mode that is used by the wireless router that the camera will to be connected to.

- **802.11b/g:** Wireless routers that support either 802.11b or 802.11g can be connected to.
- **802.11n/b/g [ShortGI disabled]:** Wireless routers that support 802.11n, 802.11b, or 802.11g can be connected to.
- **802.11n/b/g [ShortGI enabled]:** Wireless routers that support 802.11n, 802.11b, or 802.11g can be connected to.

When 802.11n/b/g [ShortGI enabled] is selected, if 802.11n transmission is used, the transmission packet intervals become shorter and the transmission speed increases. However, because the camera becomes susceptible to interference (echoes, reflections, etc.) arriving with propagation delay, the camera and wireless router should be used at short distances from each other.

- **Default:** 802.11n/b/g [ShortGI enabled]
3. Set each item of the [Wireless: Encryption settings] in accordance to the encryption method used.

WEP method

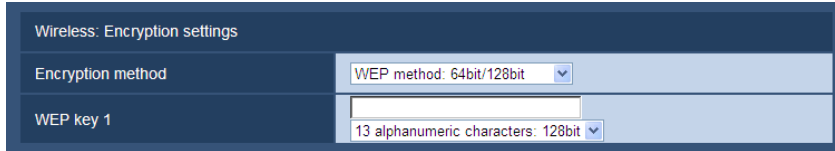

WPA-PSK (TKIP), WPA-PSK (AES), WPA-PSK (TKIP/AES), WPA2-PSK (TKIP), WPA2-PSK (AES), WPA2-PSK (TKIP/AES), or WPA/WPA2-mixedmode PSK method

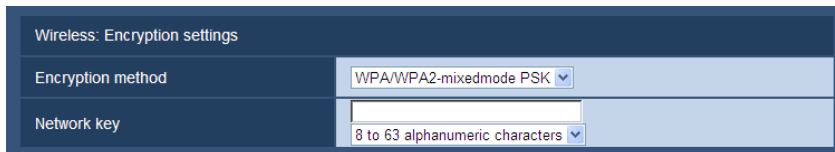

[Encryption method]

Select the encryption method for the data to be transmitted. Encryption helps protect wireless communications from being accessed or intercepted by unauthorized parties.

- **WEP method: 64bit/128bit:** Encryption is performed with 64 or 128 bit WEP method.
- **WPA-PSK (TKIP):** TKIP is used to perform encryption. Because TKIP updates the encryption key at set intervals, it has stronger encryption than WEP.
- **WPA-PSK (AES):** AES is used to perform encryption. Because AES updates the encryption key at set intervals, it has stronger encryption than WEP. Because WPA-PSK (AES) processes encryption at hardware level, it is able to contain speed losses better than when compared to WPA-PSK (TKIP), but it can only connect to devices that support it.
- **WPA-PSK (TKIP/AES):** WPA-PSK (TKIP) or WPA-PSK (AES) is automatically selected according to the encryption method used by the wireless router.
- **WPA2-PSK (TKIP):** This method has stronger encryption than WEP and WPA.
- **WPA2-PSK (AES):** This method has stronger encryption than WEP and WPA. Because WPA2-PSK (AES) processes encryption at hardware level, it is able to contain speed losses better than when compared to WPA2-PSK (TKIP), but it can only connect to devices that support it.
- **WPA2-PSK (TKIP/AES):** WPA2-PSK (TKIP) or WPA2-PSK (AES) is automatically selected according to the encryption method used by the wireless router.
- **WPA/WPA2-mixedmode PSK:** A combination of WPA-PSK (TKIP) or WPA-PSK (AES), or WPA2-PSK (TKIP) or WPA2-PSK (AES) is automatically selected according to the encryption method used by the wireless router.
- **No encryption:** Data transmission between the wireless router and camera is not encrypted.
- **Default:** No encryption

[WEP key 1]

WEP key 1 can be entered when "WEP method: 64bit/128bit" is selected for the encryption method. If the connected wireless router has key selection, select key number 1. There are 2 types of encryption keys: 64 bit and 128 bit. Generally speaking, because the longer a WEP key is the harder it is to decipher, longer keys are considered to be safer.

Select the key length from the pull-down menu.

- **10 hex characters: 64bit**
Example: 012345abcd
- **26 hex characters: 128bit**
Example: 0123456789abcdef012345abcd

- **5 alphanumeric characters: 64bit**
Example: 012yz
- **13 alphanumeric characters: 128bit**
Example: 0123456uvwxyz
- **Available number of characters:** 10 or 26 characters (10 hex characters: 64bit/26 hex characters: 128bit)/5 or 13 characters (5 alphanumeric characters: 64bit/13 alphanumeric characters: 128bit)
- **Available characters:** 0 - 9, A - F or a - f (10 hex characters: 64bit/26 hex characters: 128bit)/ alphanumeric characters (5 alphanumeric characters: 64bit/13 alphanumeric characters: 128bit)
Entries are case sensitive. Spaces cannot be entered.
- **Default:** None (blank) and 13 alphanumeric characters: 128bit

[Network key]

A network key can be entered when the “WPA-PSK (TKIP)”, “WPA-PSK (AES)”, “WPA-PSK (TKIP/AES)”, “WPA2-PSK (TKIP)”, “WPA2-PSK (AES)”, “WPA2-PSK (TKIP/AES)”, or “WPA/WPA2-mixedmode PSK” method is selected for the encryption method. Select the same network key as the network key configured to the connected wireless router.

Select the key length from the pull-down menu.

- **8 to 63 alphanumeric characters**
- **64 hex characters**
- **Available number of characters:** 8 - 63 characters
- **Available characters:** Alphanumeric characters
Entries are case sensitive. Spaces cannot be entered.
- **Default:** None (blank) and 8 to 63 alphanumeric characters

Note

- Depending on the connected wireless router, “WPA-PSK (TKIP)”, “WPA-PSK (AES)”, “WPA-PSK (TKIP/AES)”, “WPA2-PSK (TKIP)”, “WPA2-PSK (AES)”, “WPA2-PSK (TKIP/AES)”, or “WPA/WPA2-mixedmode PSK” methods may not be supported. In particular, if connections cannot be made using mixed mode methods (WPA-PSK (TKIP/AES), WPA/WPA2-mixedmode PSK, etc.), use a single mode method (WPA-PSK (TKIP), WPA-PSK (AES), etc.).
 - The camera only supports open system authentication. If shared key authentication is configured for the wireless router, change the authentication to auto or open system.
 - It is recommended to select the “WPA2-PSK (AES)” or “WPA-PSK (AES)” enhanced encryption methods for the wireless router's encryption settings.
4. Select “Disable” for “External registration” in “Wi-Fi Protected Setup (WPS)”.
 - If wireless connections are made with “Enable” selected, the wireless settings may be overwritten. Make sure to select “Disable”.
 5. Click the [Set] button.
 - A message asking you if you want to restart the camera is displayed. Click [OK]. Wait about 2 minutes until the camera restarts.
 6. Turn off the camera by unplugging the AC adaptor from the power outlet.
 7. Disconnect the LAN cable and turn on the camera by plugging the AC adaptor into the power outlet.
 - The camera starts up and starts the wireless connection.

Note

- Switch between wireless and wired connections with the following methods.
 - Wireless connections:** To use wireless connections, turn on the camera without connecting the LAN cable.
 - Wired connections:** To use wired connections, connect the LAN cable and then turn on the camera.
- When switching between wireless and wired connections, some wireless routers may have to be restarted.
- Wired and wireless connections cannot be made to the camera at the same time.

- Depending on the network environment and the wireless devices used (2.4 GHz cordless telephones/faxes or other wireless LAN devices), transmission speeds may become slower.

16.2 Connecting the camera to a wireless LAN with WPS (automatic settings) [Basic]

First, confirm that “Enable” (default setting) is set for “External registration” in “Wi-Fi Protected Setup (WPS)”. Click the [Basic] tab on the “Wireless” page. (→page 34, page 35)

The wireless settings can be easily configured on the camera using Wi-Fi Protected Setup (WPS) in this section, and the camera can connect to the wireless router.

The screenshot shows the camera's web interface with the 'Basic' tab selected. The settings are organized into several sections:

- Wireless: Basic settings**
 - SSID: [Text input field]
 - Communication mode: 802.11n/b/g [ShortGI enabled]
- Wireless: Encryption settings**
 - Encryption method: No encryption
 - WEP key 1: 13 alphanumeric characters: 128bit
- Wi-Fi Protected Setup (WPS)**
 - External registration: Enable Disable
 - WPS compliant (PIN method): Use Not use
 - PIN code: [Text input field]
- Wireless QoS (H.264 RTP transmission)**
 - Wireless QoS: Use Not use

A 'Set' button is located at the bottom of the page.

When using the camera on a wireless LAN, refer to the following procedures in accordance with your wireless LAN environment and configure the settings.

About Wi-Fi Protected Setup (WPS)

Wi-Fi Protected Setup (WPS) is a function that allows settings for connecting wireless devices and settings related to security to be easily configured.

In WPS, wireless LAN access points or wireless routers become the registrar (main device) and the wireless camera seeking to join the wireless network becomes the enrollee (periphery device). SSID or WEP/WPA/WPA2 encryption settings and other information can be sent.

There are several specific setting methods for WPS. The Push-button method (PBC) is used by pressing the wireless connection button on each device. The PIN code method is used by entering the same 8 digit PIN code into both the registrar (wireless router) and enrollee (wireless camera).

Performing settings automatically with the WIRELESS button (WPS button)

Use the camera's WIRELESS button to automatically perform wireless settings.

1. Turn on the camera without connecting the LAN cable to enable the wireless settings.
 - After the initial pan/tilt operations are performed, the POWER indicator stops blinking orange and lights orange. The POWER indicator lights orange and the camera starts up in wireless LAN mode about 90 seconds after the camera was turned on.
2. Select ON for the WPS function (Push-button method (PBC)) on the wireless router. (For more information, refer to the operating instructions included with your wireless router.)
3. Press and hold down the WIRELESS button for a second or more until the WIRELESS indicator (WPS indicator) blinks orange.
 - The camera and the wireless router automatically start performing wireless settings. Settings may take up to 2 minutes to be performed.
 - When the automatic wireless settings have been successfully completed, the camera restarts about 5 seconds after the WIRELESS indicator stops blinking orange and lights green. The WIRELESS indicator goes off, and after about 90 seconds lights green again when the wireless connection has been successfully completed.
 - The wireless settings are updated.
4. After the WIRELESS indicator lights green, start the “IP Setting Software” on the PC and access the camera.
 - See page 161 for information on accessing the camera with the “IP Setting Software”.
 - Confirm the status of the wireless connection on the [Status] tab of the “Wireless” page. (→page 148)

Note

- If about 2 minutes pass after the WIRELESS indicator starts blinking and the wireless connection is not completed, the WIRELESS indicator will blink red for about 10 seconds and then go off. If this happens the wireless settings have failed. Check the wireless router's settings and connection procedures, and then try performing the settings again.
- If the WPS settings fail to automatically configure, check the settings of the wireless router and the camera.
- If you want to turn off the WIRELESS indicator's and POWER indicator's green light, change the “Indicator” settings on the “Basic” page. (→page 41)
- When the WPS settings have successfully been automatically configured, “External registration” is changed to “Disable” from “Enable”.

Performing settings automatically with PIN code settings

There are 2 methods for performing settings automatically with PIN code settings: using the PIN code preset to the wireless router or using a selected PIN code set to the camera.

Using the PIN code configured to the wireless router

1. Check the preset 8 digit PIN code of the wireless router with a PC.
 - For more information on how to check the preset PIN code of the wireless router, refer to the operating instructions included with your wireless router.
 - Depending on the wireless router used, the PIN code (default setting) may be written on a sticker attached to the wireless router.
2. Connect the PC to the camera with a wired LAN connection and click the [Basic] tab on the “Wireless” page.

3. Configure [Wi-Fi Protected Setup (WPS)].



- Select “Enable” for “External registration”. (Default: Enable)
- Select “Use” for “WPS compliant (PIN method)”. (Default: Not use)
- Enter the wireless router’s 8 digit PIN code in the “PIN code” field.
 - **Available number of characters:** 8 characters
 - **Available characters:** Numbers
 - **Default:** None (blank)

Note

- When “Use” is selected for “WPS compliant (PIN method)”, settings cannot be performed automatically using the WIRELESS button during start up for the PIN method.

4. Click the [Set] button.
 - A message asking you if you want to restart the camera is displayed. Click [OK]. Wait about 2 minutes until the camera restarts.
5. Disconnect the LAN cable from the camera and reconnect the camera to the power outlet.
 - The camera will start about 90 seconds after connecting the power.
 - After the camera is started, the WPS settings are only active for about 2 minutes. Therefore, perform the settings in step 6 as quickly as possible (within 2 minutes).
6. Select ON for the WPS function (PIN code method) on the wireless router. (For more information, refer to the operating instructions included with your wireless router.)
 - Settings between the wireless router and the camera will automatically start.
 - The WIRELESS indicator stops blinking orange and lights green. When the POWER indicator lights green, the wireless settings have been successfully completed.
7. After the WIRELESS indicator lights green, start the “IP Setting Software” on the PC and access the camera.
 - See page 161 for information on accessing the camera with the “IP Setting Software”.
 - Confirm the status of the wireless connection on the [Status] tab of the “Wireless” page. (→page 148)

Note

- If about 2 minutes pass after the WIRELESS indicator starts blinking and the wireless connection is not completed, the WIRELESS indicator will blink red for about 10 seconds and then go off. If this happens the wireless settings have failed. Check the wireless router’s settings and connection procedures, and then try performing the settings again.
- If the WPS settings fail to automatically configure, check the settings of the wireless router and the camera.
- If you want to turn off the WIRELESS indicator’s and POWER indicator’s green light, change the “Indicator” settings on the “Basic” page. (→page 41)
- When the WPS settings have successfully been automatically configured, “External registration” is changed to “Disable” from “Enable”.

Using a selected PIN code set to the camera

1. Connect the PC to the camera with a wired LAN connection and click the [Basic] tab on the “Wireless” page.

2. Configure [Wi-Fi Protected Setup (WPS)].

Wi-Fi Protected Setup (WPS)	
External registration	<input checked="" type="radio"/> Enable <input type="radio"/> Disable
WPS compliant (PIN method)	<input checked="" type="radio"/> Use <input type="radio"/> Not use
PIN code	<input type="text" value="21963247"/> <input type="button" value="Generate"/> <input type="button" value="Default"/>

- Select “Enable” for “External registration”. (Default: Enable)
- Select “Use” for “WPS compliant (PIN method)”. (Default: Not use)
- Click the [Generate] button or [Default] button to set the “PIN code”.
 - **Available number of characters:** 8 characters
 - **Available characters:** Numbers
 - **Default:** None (blank)

Note

- The [Generate] button of “PIN code” generates a random 8 digit PIN code.
- The [Default] button of “PIN code” sets a preset 8 digit PIN code.
- When “Use” is selected for “WPS compliant (PIN method)”, settings cannot be performed automatically using the WIRELESS button during start up for the PIN method.

3. Click the [Set] button.

→ A message asking you if you want to restart the camera is displayed. Click [OK]. Wait about 2 minutes until the camera restarts.

4. Disconnect the LAN cable from the camera and reconnect the camera to the power outlet.

→ The camera will start about 90 seconds after connecting the power.

- After the camera is started, the WPS settings are only active for about 2 minutes. Therefore, perform the settings in step 5 and restart the wireless router as quickly as possible (within 2 minutes).

5. Enter the camera's 8 digit PIN code into the wireless router, and restart the wireless router with the WPS PIN code method.

- For more information, refer to the operating instructions included with your wireless router.

→ Settings between the wireless router and the camera will automatically start.

→ The WIRELESS indicator stops blinking orange and lights green. When the POWER indicator lights green, the wireless settings have been successfully completed.

6. After the WIRELESS indicator lights green, start the “IP Setting Software” on the PC and access the camera.

- See page 161 for information on accessing the camera with the “IP Setting Software”.
- Confirm the status of the wireless connection on the [Status] tab of the “Wireless” page. (→page 148)

Note

- If about 2 minutes pass after the WIRELESS indicator starts blinking and the wireless connection is not completed, the WIRELESS indicator will blink red for about 10 seconds and then go off. If this happens the wireless settings have failed. Check the wireless router's settings and connection procedures, and then try performing the settings again.
- If the WPS settings fail to automatically configure, check the settings of the wireless router and the camera.
- If you want to turn off the WIRELESS indicator's and POWER indicator's green light, change the “Indicator” settings on the “Basic” page. (→page 41)
- When the WPS settings have successfully been automatically configured, “External registration” is changed to “Disable” from “Enable”.

IMPORTANT

If the wireless settings failed to be automatically set with WPS, check the wireless settings for the wireless router and camera in the following manner.

Checking wireless settings for the wireless router

- If the wireless setting of the wireless router is set to a setting not supported by the camera, change the wireless setting of the wireless router.
- Confirm that the WPS function is activated. It is recommended that you deactivate the wireless router's WPS function when not performing WPS settings.
- If the ESS-ID stealth function (hidden SSID) is activated, temporarily deactivate it.
- If MAC address filtering is activated, temporarily deactivate it.

Checking wireless settings for the camera

- Confirm that "Enable" (default setting) is set for "External registration".
- It is recommended to select the "WPA2-PSK (AES)" or "WPA-PSK (AES)" enhanced encryption methods for the wireless router's encryption settings.

16.3 Using the camera's Wireless QoS [Basic]

Click the [Basic] tab on the "Wireless" page. (→page 34, page 35)
Configure the wireless QoS (Quality of Service) in this section.

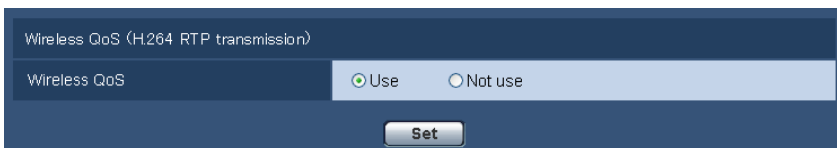

[Wireless QoS]

Wireless QoS is only available when using H.264 RTP transmission. When the wireless frequency band is temporarily reduced because of external interference, images may not be displayed. When this happens, Wireless QoS helps to reduce transmission delays and dropped frames by converting images into data that can be displayed and then transmitting the data.

- **Default:** Use

Note

- JPEG/audio transmissions and transmissions using HTTP are not applicable to Wireless QoS.
- Wireless QoS is not effective against strong interference that can shut down wireless transmission.
- To use H.264 RTP transmission, select "Off" for "Internet mode (over HTTP)" in "H.264(1)" or "H.264(2)" on page 49. Use H.264 RTP transmission when H.264 transmission is used on the local LAN.

16.4 Confirming the camera's wireless information [Status]

Click the [Status] tab on the "Wireless" page. (→page 34, page 35)
Information related to the camera's wireless connection is displayed in this section.

Note

- The screen is refreshed in 10 seconds intervals periodically to monitor the radio wave status. This may cause the screen to flicker.

Basic		Status
Wireless information		
Wireless module status	Already connected to the wireless router	
Firmware version (Wireless)	3.9.2	
Operation mode	Wireless	
Auto setup (WPS)	Already been set	
Mac address of the wireless module	00-00-00-00-00-00	
Communication mode	802.11n/b/g [ShortGI enabled]	
SSID	XXXX	
Channel	1	
BSSID	00-00-00-00-00-00	
Authentication method	WPA2-PSK	
Encryption method	AES	
Radio wave status	100% Good XXX	

[Wireless module status]

Displays the current status of the wireless module.

[Firmware version (Wireless)]

Displays the wireless firmware version of the camera.

[Operation mode]

Displays the camera's operation mode (Wired or Wireless).

[Auto setup (WPS)]

When the camera has successfully completed Wi-fi Protected Setup (WPS) settings with the wireless router, "Already been set" is displayed.

If the wireless settings are manually changed after "Already been set" is displayed, "Not set" will be displayed. The "Already been set" display is linked to the camera's WIRELESS indicator (green light).

[Mac address of the wireless module]

Displays the camera's wireless module's MAC address. When the wireless router limits access with MAC address filtering, register the wireless module's MAC address displayed here (the camera's MAC address) to the wireless router. (→page 156)

[Communication mode]

Displays the currently used communications mode (802.11b/g, 802.11n/b/g [ShortGI disabled], or 802.11n/b/g [ShortGI enabled]).

[SSID]

Displays the connected wireless router's SSID (network identification name).

[Channel]

Displays the connected wireless router's wireless channel.

[BSSID]

Displays the connected wireless router's MAC address. When a wireless router is not connected, "00-00-00-00-00-00" is displayed.

[Authentication method]

Displays the authentication method (Open System, WPA-PSK, or WPA2-PSK) in accordance to the currently selected encryption method.

[Encryption method]

Displays the currently selected encryption method (WEP, TKIP, or AES).

[Radio wave status]

Displays the signal strength (Bad, Normal, Good). These figures are just a guide and may not match the actual wireless communication status.

The signal strength and connection status are displayed as follows.

- **Good:** When the signal strength is about 60%-100%
- **Normal:** When the signal strength is about 15%-59%
- **Bad:** When the signal strength is about 0%-14%

17 Configure the settings relating to the schedules [Schedule]

On the “Schedule” page, it is possible to configure the settings relating to schedules as follows.

- Alarm permission (Alarm input will be received only in the specified schedule.)
- VMD permission (Video motion detection will be active only in the specified schedule.)
- **VT164W** **VT164**: Body heat sensor permission (The body heat sensor detection will be active during the period of the schedule.)
- Access permission (Access to the camera will be allowed only in the specified schedule.)

The “Schedule” page has only the [Schedule] tab.

Up to 5 schedules can be set.

17 Configure the settings relating to the schedules [Schedule]

The screenshot displays the 'Schedule' configuration page. It features a table with five rows, each representing a schedule. The first row, 'Schedule 1 (White)', is highlighted with a pink border. Each row includes a 'Schedule mode' dropdown menu (all set to 'Off') and a 'Time range' section with radio buttons for days of the week and a time range selector (all set to '24h 00:00 - 00:00'). Below the table is a 'Set' button and a weekly schedule grid with columns for 0:00, 6:00, 12:00, 18:00, and 24:00, and rows for Mon, Tue, Wed, Thu, Fri, Sat, and Sun.

Schedule	Schedule mode	Time range
Schedule 1 (White)	Off	Mon, Tue, Wed, Thu, Fri, Sat, Sun; 24h 00:00 - 00:00
Schedule 2 (Blue)	Off	Mon, Tue, Wed, Thu, Fri, Sat, Sun; 24h 00:00 - 00:00
Schedule 3 (Green)	Off	Mon, Tue, Wed, Thu, Fri, Sat, Sun; 24h 00:00 - 00:00
Schedule 4 (Red)	Off	Mon, Tue, Wed, Thu, Fri, Sat, Sun; 24h 00:00 - 00:00
Schedule 5 (Black)	Off	Mon, Tue, Wed, Thu, Fri, Sat, Sun; 24h 00:00 - 00:00

Set

	0:00	6:00	12:00	18:00	24:00
Mon					
Tue					
Wed					
Thu					
Fri					
Sat					
Sun					

1. Select an action to be assigned to the schedule from "Schedule mode".
"Off" is selected at the default.
 - **Off:** No action will be taken for the respective schedule.
 - **Alarm permission:** Alarm input (terminal alarm) will be received during the period of the schedule.
 - **VMD permission:** The video motion detection (VMD) function will be active during the period of the schedule.

- **Body heat sensor permission** **VT164W** **VT164**: The body heat sensor detection will be active during the period of the schedule.
- **Access permission**: Users whose access level is set to 2 and 3 on the “User auth.” tab (→page 94) can access the camera only in the period of schedule.
- **1-64** **VT164W** **VT164**: The camera will move to the designated preset position at the designated time in the schedule.

Note

- Select “On” for “User auth.” on the [User auth.] tab of “User mng.” page (→page 94) and “Off” for “Host auth.” on the “Host auth.” page (→page 95) to validate “Access permission”.
2. Select days of a week by checking the respective checkboxes.
 3. From the pull-down menu, select the start time and the end time of the schedule.
When not designating time, check the checkbox of “24h”.
 4. Click the [Set] button after completing the settings.
→ The result will be displayed at the bottom of the window.

Note

- The schedules displayed at the bottom of the window can be identified by colors assigned to each schedule.

18 Maintenance of the camera [Maintenance]

System log check, firmware upgrade, status check and initialization of the setup menu can be performed on this page.

The “Maintenance” page has 4 tabs; the [System log] tab, the [Upgrade] tab, [Status] tab and the [Default reset] tab.

18.1 Check the system log [System log]

Click the [System log] tab of the “Maintenance” page. (→page 34, page 35)

Up to 100 system logs can be saved on the built-in memory of the camera.

When the saved system logs have reached the maximum number, the newer logs will overwrite the older system logs. In this case, the oldest log is the first to be overwritten.

The logs will be deleted when the power of the camera is turned off.

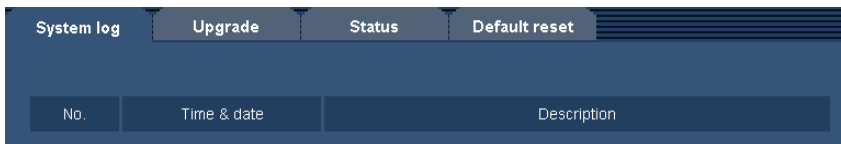

[No.]

The serial number of the system log will be displayed.

[Time & date]

Time and date at the error occurrence will be displayed.

Note

- When “Off” is selected for “Time display format” on the [Basic] page (→page 39), time & date of logs will be displayed in 24-hour format.

[Description]

The descriptions about the system log will be displayed. Refer to page 166 for further information about the system logs.

18.2 Upgrade the firmware [Upgrade]

Click the [Upgrade] tab of the “Maintenance” page. (→page 34, page 35)

The current firmware can be checked and upgraded to the latest version on this page. Contact the dealer for further information about the firmware upgrade.

The screenshot shows a web interface with a navigation bar containing 'System log', 'Upgrade', 'Status', and 'Default reset'. The 'Upgrade' tab is active. Below the navigation bar is a table displaying system information:

Model no.	[Model no.]	
MAC address	[MAC address]	
Serial no.	[Serial no.]	
Firmware version	1 Application: [Firmware version] 2 Image data: [Firmware version]	
IPL version	[IPL version]	
HTML version	[HTML version]	
IP address(IPv6)	Linklocal	[IP address(IPv6)]
	Static	
	RA	
	DHCPv6	
Viewer software installation counter	[Viewer software installation counter]	

Below the table is a form for the firmware upgrade process. It includes a 'Browse...' button for selecting a file, a radio button selection for 'Reset the settings to the default after completing the upgrade. (Except the network settings)' (which is selected) and 'Do not reset the settings to the default after the upgrade.', and an 'Execute' button. A note below the form states: 'It will take around 9 minutes to complete the upgrade. Please wait and do not operate the browser during this process.'

[Model no.], [MAC address], [Serial no.], [Firmware version], [IPL version], [HTML version], [IP address(IPv6)], [Viewer software installation counter]

Information of each item will be displayed.

1. Contact the dealer and download the latest firmware onto a PC.

IMPORTANT

- A blank (space) cannot be used for the name of the directory where the downloaded firmware to be saved.
2. Click the [Browse...] button and designate the downloaded firmware.
 3. Click the radio button respective to the desired option to determine whether or not to initialize the settings after completing the firmware upgrade.

Note

- Note that the settings cannot be restored after an initialization is operated.
4. Click the [Execute] button.
 - The confirmation window will be displayed. When “Do not reset the settings to the default after the upgrade.” is selected, the confirmation window will not be displayed.

IMPORTANT

- After completing the upgrade, delete temporary internet files. (→page 170)
- Upgrade the firmware using a PC in the same subnet as the unit.
- Follow the instructions from the dealer when upgrading the firmware.
- When upgrading the application software, use the designated file (extension: img) for the firmware upgrade.

The name of the firmware to be used for the upgrade should be “model name (Use small letters. “BL-” is not required.)_xxxxx.img”.

* (“xxxxx” indicates the version of the firmware.)

- Do not turn off the power of the camera during the upgrade process.
- Do not perform any operation during upgrading and wait until it completes.
- The viewer software used on each PC should be licensed individually. Refer to your dealer for the software licensing.

VT164W **VT164**:

- The preset position settings will not be reset when upgrading the firmware after selecting “Reset the settings to the default after completing the upgrade. (Except the network settings)”.

VT164W **VP104W**:

- The following network settings will not be reset when upgrading the firmware after selecting “Reset the settings to the default after completing the upgrade. (Except the network settings)”.

On/Off for DHCP, IP address, subnet mask, default gateway, HTTP port, HTTPS port, connection protocol (HTTP/HTTPS), CRT key, server certificate, UPnP setting, line speed, bandwidth control (bit rate), SSID, communication mode, encryption method, WEP key 1, external registration, WPS compliant (PIN method), PIN code, Wireless QoS, time & date

VT164 **VP104** **VP101**:

- The following network settings will not be reset when upgrading the firmware after selecting “Reset the settings to the default after completing the upgrade. (Except the network settings)”.

On/Off for DHCP, IP address, subnet mask, default gateway, HTTP port, HTTPS port, connection protocol (HTTP/HTTPS), CRT key, server certificate, UPnP setting, line speed, bandwidth control (bit rate), time & date

18.3 Check the status [Status]

Click the [Status] tab of the “Maintenance” page. (→page 34, page 35)

The status of this camera can be checked on this page.

System log	Upgrade	Status	Default reset
Viewnetcam.com			
Server			
Status	Disable		
Personal(Camera) URL			
UPnP			
Port number(HTTP)	-		
Status	Disable		
Port number(HTTPS)	-		
Status	Disable		
Router global address			
Self check			
Hardware1	0000-0000-0000-0000-0000-0000-0000-00		

[Viewnetcam.com]

- **Server:** The URL of the “Viewnetcam.com” service server will be displayed.
- **Status:** The registration status for the “Viewnetcam.com” will be displayed.
- **Personal(Camera) URL:** The URL of the camera registered for “Viewnetcam.com” will be displayed.

[UPnP]

- **Port number(HTTP), Port number(HTTPS):** The port number that is set for UPnP port forwarding will be displayed.
- **Status:** The port forwarding status will be displayed.
- **Router global address:** The global address of router will be displayed.

[Self check]

The self check result of the hardware will be displayed.

Note

- Refer to the [Readme] file on the provided CD-ROM for further information about the contents of the displayed statuses (relating to the “Viewnetcam.com” service, the UPnP function, or the self check). Or refer to our website (<http://panasonic.net/pss/security/support/info.html>) for further information about the supported software.

18.4 Reset the settings/Reboot the camera [Default reset]

Click the [Default reset] tab of the “Maintenance” page. (→page 34, page 35)

The settings and the HTML data of the camera can be initialized and reboot of the camera can be performed on this page.

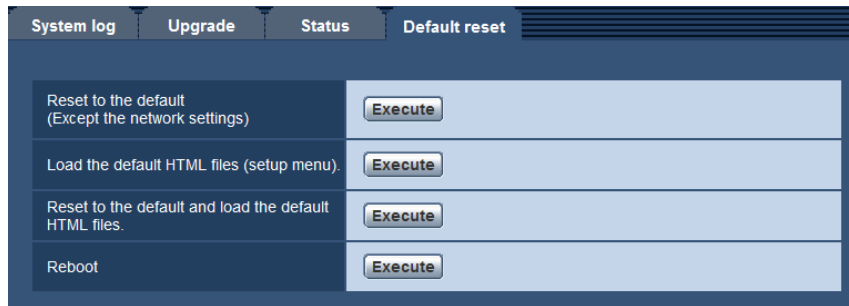

[Reset to the default (Except the network settings)]

Click the [Execute] button to reset the settings to the default. Note that the network and wireless^{*1} settings will not be reset.

It is impossible to operate the camera for about 3 minutes after the initialization.

[Load the default HTML files (setup menu).]

Click the [Execute] button to reset the HTML files to the default.

It is impossible to operate the camera for about 3 minutes after the initialization.

[Reset to the default and load the default HTML files.]

Click the [Execute] button to reset the settings of the camera and the HTML files to the default. Note that the network and wireless^{*1} settings will not be reset.

It is impossible to operate the camera for about 3 minutes after the initialization.

[Reboot]

Click the [Execute] button to reboot the camera. It is impossible to operate the camera for about 2 minutes after rebooting the camera.

Note

- To initialize the network settings (→page 104), turn off the power of the camera, then turn on the power again while holding down the INITIAL SET button on the unit, and keep the INITIAL SET button held down for about 5 seconds. Wait about 3 minutes after releasing the button. The camera will start up and the settings including the network settings will be initialized. Do not turn off the power of the unit about 3 minutes after turning on the power.

*1 **VT164W** **VP104W**

19 Privacy Mode (BL-VT164W/BL-VT164)

Privacy mode allows you to protect your privacy by hiding the lens inside the camera, preventing camera images from being seen. When privacy mode is activated:

- The POWER indicator turns red so that you can easily see that privacy mode is activated.
- The live image changes to a black display.
- JPEG images attached to “Alarm image” transfers, “FTP img. trans.” transfers, and “E-mail” transfers change to black images.
- Body heat sensor operates normally. Body heat sensor information is notified by E-mail or FTP depending on the setting status even when Privacy mode is active.
- Audio is deactivated.

The privacy mode can be activated and deactivated with 3 methods: pressing the PRIVACY button on the camera, using the [Privacy] button in the setup menu, and accessing the camera from a cellular phone/mobile terminal as the administrator (→page 19, page 22).

19.1 Configuring the Privacy Mode with the PRIVACY button

In order to operate the privacy mode with the PRIVACY button on the camera, the PRIVACY button must be enabled on the [Cam. Function] tab of the “Image/Audio” page. (→page 56)

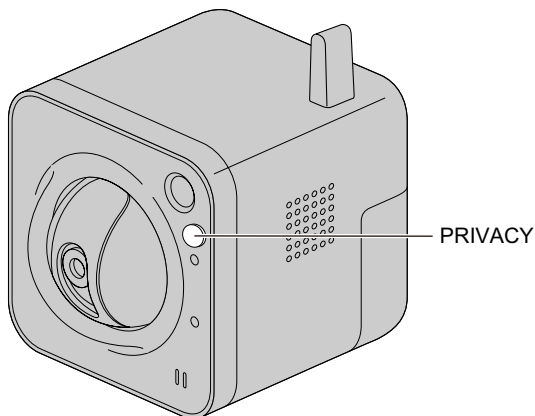

1. Press the PRIVACY button on the camera.
 - The lens will be hidden in the top part of the camera and the POWER indicator will light.

19.2 Configuring the Privacy Mode with the setup menu

1. Click the [Privacy] button in the setup menu.
→ The lens will be hidden in the top part of the camera and the POWER indicator will light.

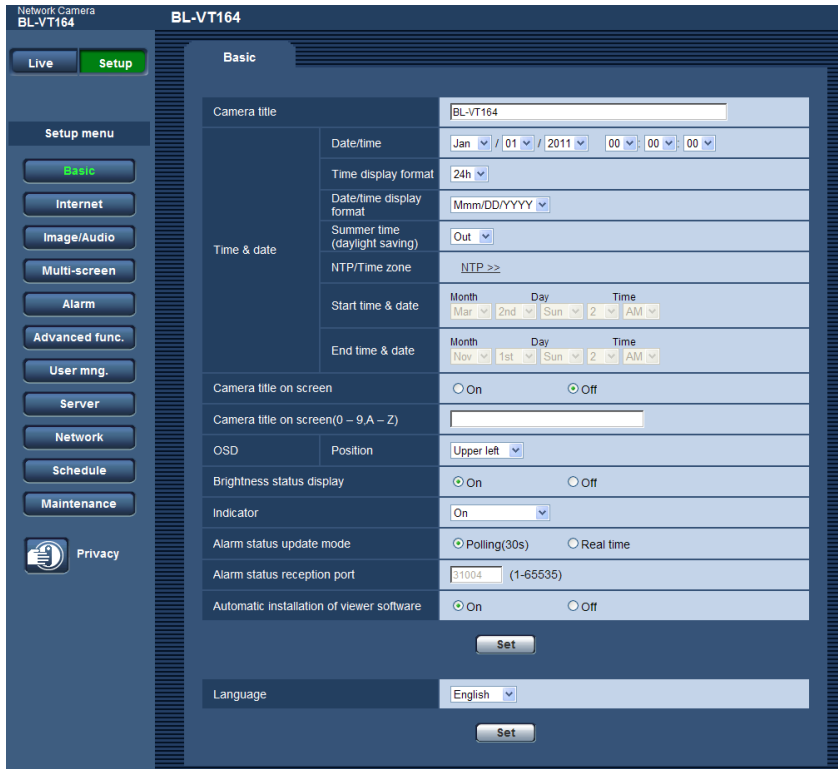

19.3 Turning the Privacy Mode off

You can turn privacy mode off by:

- Pressing the camera's PRIVACY button (the POWER indicator will turn from red to green).
- Accessing the camera with a PC. When the following dialog is displayed, click "Disable Privacy Mode" and enter the administrator user name and password if prompted.

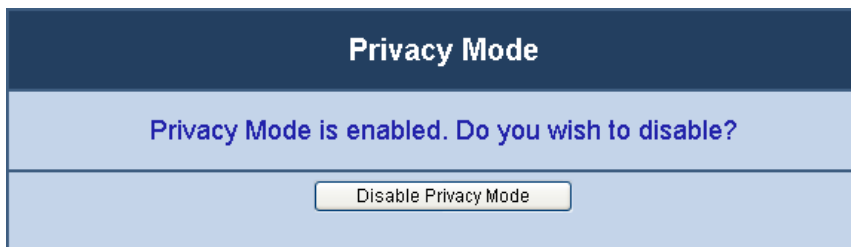

- Accessing the camera from a cellular phone/mobile terminal as the administrator (→page 19, page 22).

20 Using the CD-ROM

20.1 About the CD launcher

By inserting the provided CD-ROM into the CD-ROM drive of your PC, the CD launcher is automatically started and the license agreement is displayed. Read the agreement and select "I accept the terms in the license agreement", and then click "OK".

- If the launcher window is not displayed, double click the "CDLauncher.exe" file on the CD-ROM.

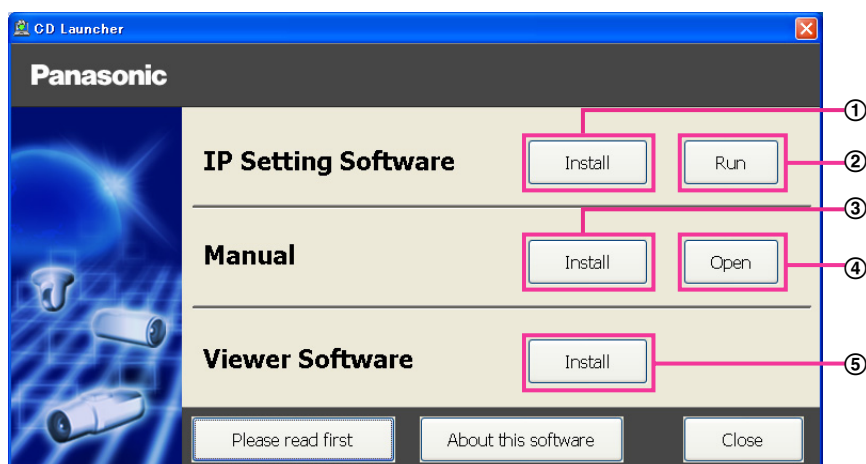

Using the supplied CD-ROM, the following actions can be performed.

- ① The Panasonic "IP Setting Software" can be installed on the PC. (→page 162)
- ② Settings related to the camera's network can be set from the Panasonic "IP Setting Software". (→page 164)
- ③ The manuals can be installed on the PC. (→page 163)
- ④ You can also view the manuals without installing them to the PC by clicking the [Open] button.
- ⑤ The Viewer software can be installed on the PC. (→page 163)

Make sure to read the [Readme] file on the provided CD-ROM before using the software.

20.2 Installing Panasonic “IP Setting Software”

On the CD launcher window, click the [Install] button next to [IP Setting Software] to display the Panasonic “IP Setting Software” installation window. Confirm the following settings before starting the installation.

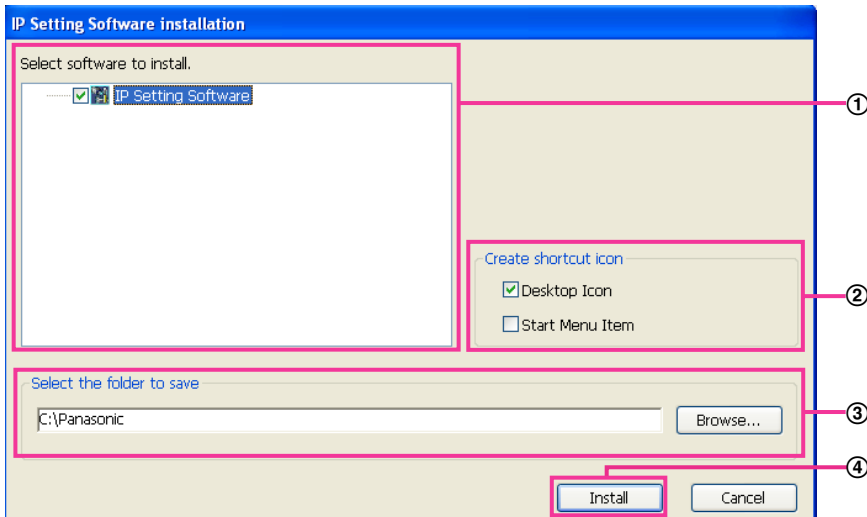

- ① Select the Panasonic “IP Setting Software” to install.
- ② Select where to create the Panasonic IP setting shortcut icon when the Panasonic “IP Setting Software” is installed.
- ③ Specify which folder on the PC to install the Panasonic “IP Setting Software” to.
- ④ Click the [Install] button to start the installation.

Note

- To uninstall the Panasonic “IP Setting Software” delete the shortcut icon from where you specified it to be installed (the default is on the desktop) during installation and the [EasyIPConfig] folder from the folder (the default is C:\Panasonic) you specified during installation.

20.3 Installing the manuals

On the CD launcher window, click the [Install] button next to [Manual] to display the Manual installation window. Confirm the following settings before starting the installation.

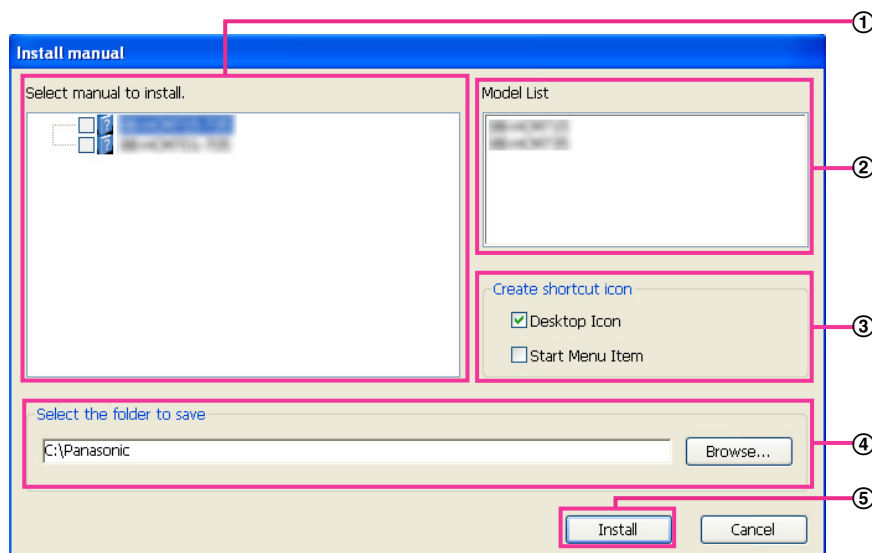

- ① Select which manuals to install. The camera models that the manuals support are displayed in ② "Model List".
- ② The camera models that are supported by the manuals selected in ① are displayed here.
- ③ Select where to create the manuals shortcut icon when the manuals are installed.
- ④ Specify which folder on the PC to install the manuals to.
- ⑤ Click the [Install] button to start the installation.

Note

- To uninstall the manuals delete the shortcut icon from where you specified it to be installed (the default is on the desktop) during installation and the [Manual] folder from the folder (the default is C:\Panasonic) you specified during installation.

20.4 Installing the Viewer software

The Viewer software (Network Camera View 4S) must be installed on the PC in order to display camera images. On the CD launcher window, click the [Install] button next to [Viewer Software], and follow the instructions displayed on the window to install the software. A message is displayed if a PC that does not have the Viewer software installed tries to access the camera. Install the software by following the instructions displayed on the window. Refer to page 3 for further information.

Note

- To uninstall the Viewer software, follow the steps below depending on the OS used on your PC.
 - For Windows XP**
Delete [Network Camera View 4S] from [Control Panel] - [Add or Remove Programs].
 - For Windows Vista/Windows 7**
Delete [Network Camera View 4S] from [Control Panel] - [Programs] - [Uninstall a program].

20.5 Configure the network settings of the camera using the Panasonic “IP Setting Software”

It is possible to perform the network settings of the camera using the “IP Setting Software” on the provided CD-ROM. When using multiple cameras, it is necessary to configure the network settings of each camera independently. If the Panasonic “IP Setting Software” does not work, configure the network settings of the camera and the PC individually on the “Network” page of the setup menu. (→page 104)

IMPORTANT

- When using Windows 7 or Windows Vista, the “Windows Security Alert” window may be displayed when starting the “IP Setting Software”. In this case, disable “User Account Control” from the control panel.
 - For the security enhancement, the “Network Settings” will not be able to be performed when around 20 minutes have passed after turning on the power of the camera. (When the effective period is set to “20min” in the IP setup.)
 - Panasonic “IP Setting Software” is inoperable in other subnets via the same router.
 - This camera cannot be displayed or set with an older version of the “IP Setting Software” (version 2.xx).
1. To start the Panasonic “IP Setting Software”, click the [Run] button next to [IP Setting Software] from the CD launcher menu window, or double-click on the shortcut icon created after installing the software on the PC.
 - The License Agreement will be displayed. Read the Agreement and choose “I accept the terms in the license agreement”, and click [OK].
 2. Click the [Network Settings] button after selecting the MAC address/IP address of the camera to be configured.

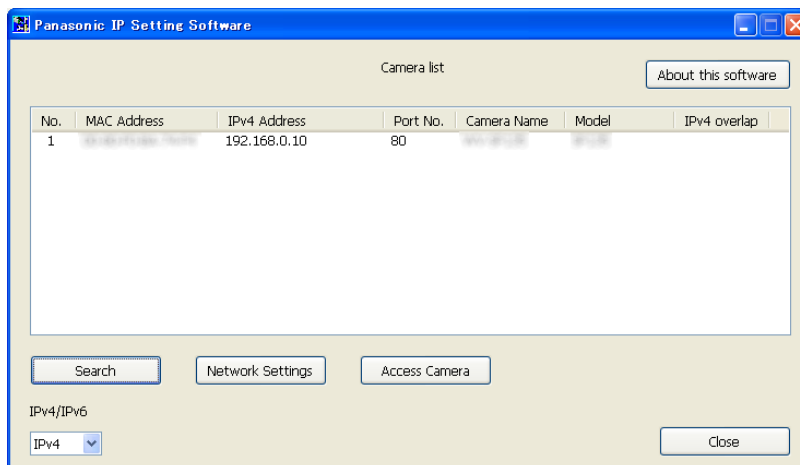

Note

- When using a DHCP server, the IP address assigned to the camera can be displayed by clicking the [Search] button of the “IP Setting Software”.
- When a duplicate IP address is used, the corresponding camera number will be displayed shaded.
- When the [Access Camera] button is clicked, live images of the selected camera will be displayed.
- It is possible to change the “Camera list” display between IPv4 addresses and IPv6 addresses in accordance with the protocol in use.
- The information displayed can be sorted by clicking the title of each displayed item.

3. Complete each network setup item and click the [Save] button.
 - For further information about each setting of the “Network Settings” page, refer to page 104.

Network Settings

Network Settings StaticIP DHCP
 Auto(AutoIP) Auto(Advanced)

Port No.

IPv4 Address

Subnet Mask

Default Gateway

DNS Auto Manual

Primary DNS

Secondary DNS

Wait for camera restarting.

Note

- By unchecking the “Wait for camera restarting.” checkbox, multiple cameras can be continuously configured.

IMPORTANT

- It may take for around 2 minutes to complete to upload the settings to the camera after clicking the [Save] button. The settings may be invalidated when the LAN cable is disconnected before completing the upload. In this case, perform the settings again.
- When using a firewall (including software), allow access to all UDP ports.

21 About the displayed system log

Error indications relating to SMTP

Category	Indication	Description
POP3 server error	Authentication error.	<ul style="list-style-type: none"> Entered user name or password may be incorrect. Check if the E-mail settings are configured correctly.
	Failed to find the POP3 server.	<ul style="list-style-type: none"> The IP address of the server may be incorrect. Check if the IP address of the server is configured correctly. The POP3 server may be down. Ask the network administrator.
SMTP server error	Authentication error.	<ul style="list-style-type: none"> Entered user name or password may be incorrect. Check if the E-mail settings are configured correctly.
	Failed to resolve the E-mail server address from DNS.	<ul style="list-style-type: none"> The designated IP address of the DNS may be incorrect. Check if the DNS settings are configured correctly. The DNS server may be down. Ask the network administrator.
	Failed to find the SMTP server.	<ul style="list-style-type: none"> The IP address of the server may be incorrect. Check if the IP address of the server is configured correctly. The SMTP server may be down. Ask the network administrator.
Internal error	Undefined error.	<ul style="list-style-type: none"> An error occurred in the E-mail function. Check if the E-mail settings are configured correctly.

Error indications relating to FTP

Category	Indication	Description
FTP server error	Failed to resolve the FTP server address from DNS.	<ul style="list-style-type: none"> The FTP server may be down. Ask the network administrator.
	Failed to find the FTP server.	<ul style="list-style-type: none"> The IP address of the server may be incorrect. Check if the IP address of the server is configured correctly.
Connection error	File transfer error.	<ul style="list-style-type: none"> The FTP server settings may be incorrect. Check if the FTP settings are configured correctly.
	Passive mode error.	
	Log out failed.	<ul style="list-style-type: none"> The settings relating to the indicated item may be incorrect. Check if the FTP settings are configured correctly.
	Failed to change the directory.	
	User name or password isn't correct.	

Category	Indication	Description
Internal error	Undefined error.	<ul style="list-style-type: none"> An error occurred in the FTP function. Check if the FTP settings are configured correctly.

Error indications relating to “Viewnetcam.com”

Category	Indication	Description
Viewnetcam.com server error	Failed to resolve the Viewnetcam.com server address from DNS.	<ul style="list-style-type: none"> The designated IP address of the DNS may be incorrect. Check if the DNS settings are configured correctly. The DNS server may be down. Ask the network administrator.
Connection error	No response from the Viewnetcam.com server.	<ul style="list-style-type: none"> The “Viewnetcam.com” server may be down. Ask the network administrator.
	File transfer error.	
Internal error	Undefined error.	<ul style="list-style-type: none"> An error relating to the “Viewnetcam.com” function occurred. Check if the “Viewnetcam.com” settings are configured correctly.

Error indications relating to Dynamic DNS Update

Category	Indication	Description
DDNS server error	Failed to resolve the DDNS server address from DNS.	<ul style="list-style-type: none"> The designated IP address of the DNS may be incorrect. Check if the DNS settings are configured correctly. The DNS server may be down. Ask the network administrator.
Connection error	No response from the DDNS server.	<ul style="list-style-type: none"> The DDNS server may be down. Ask the network administrator.
	Same host name has registered.	<ul style="list-style-type: none"> The same host name has already been registered in the DDNS server. Check if the DDNS Update settings are configured correctly.
Internal error	Undefined error.	<ul style="list-style-type: none"> An error occurred in the DDNS function. Check if the DDNS Update settings are configured correctly.

Error indications relating to NTP

Category	Indication	Description
Connection error	No response from the NTP server.	<ul style="list-style-type: none"> The IP address of the server may be incorrect. Check if the IP address of the server is configured correctly. The NTP server may be down. Ask the network administrator.
Internal error	Undefined error.	<ul style="list-style-type: none"> An error occurred in the NTP function. Check if the NTP settings are configured correctly.
Synchronizing with NTP succeeded.	NTP update succeeded.	<ul style="list-style-type: none"> Time correction succeeded.

Log indications relating to HTTPS

Category	Indication	Description
HTTPS	Self-signed Certificate - Generated	<ul style="list-style-type: none"> Generation of the self-signed certificate is complete.
	Self-signed Certificate - Deleted	<ul style="list-style-type: none"> Deletion of the self-signed certificate is complete.
	Certificate Signing Request - Generated	<ul style="list-style-type: none"> Generation of the CSR (Certificate Signing Request) is complete.
	CA Certificate - Installed	<ul style="list-style-type: none"> Installation of the server certificate is complete.
	CA Certificate - Deleted	<ul style="list-style-type: none"> Deletion of the server certificate is complete.
	Previous CRT key - Applied	<ul style="list-style-type: none"> Previous CRT key is applied.
	CRT key - Generated	<ul style="list-style-type: none"> Generation of the CRT key is complete.

Log indications relating to login

Category	Indication	Description
Login	User name or IP address	<ul style="list-style-type: none"> The login user name will be displayed when "On" is selected for "User auth." The IP address of the PC currently accessing to the camera will be displayed when "On" is selected for "Host auth."

Error indications relating to Panasonic alarm protocol notification

Category	Indication	Description
Panasonic alarm protocol notification error	Failed to find destination of notification.	<ul style="list-style-type: none"> The IP address of the destination of notification may be incorrect. Check if the IP address of the destination of notification is configured correctly. The destination of notification may be down. Ask the network administrator.
	Cannot resolve notification addresses from DNS	<ul style="list-style-type: none"> The DNS server settings may be incorrect. Check if the DNS settings are configured correctly. The DNS server may be down. Ask the network administrator.

22 Troubleshooting

Before asking for repairs, check the symptoms with the following table.

Contact your dealer if a problem cannot be solved even after checking and trying the solution in the table or a problem is not described below.

Symptom	Cause/solution	Reference pages
Cannot access from the web browser.	<ul style="list-style-type: none"> Is the LAN cable (category 5) firmly connected to the network connector of the camera? 	Installation Guide
	<ul style="list-style-type: none"> Is the power of the camera on? Check if the power of the camera is turned on. 	Installation Guide
	<ul style="list-style-type: none"> Are the set IP addresses valid? 	104
	<ul style="list-style-type: none"> Are you accessing the wrong IP address? Check the connection as follows. With the Windows command prompt, > ping "IP address of the camera". If there is reply from the camera, the connection is normal. If not, proceed either of the following. <ul style="list-style-type: none"> Reboot the camera and change the IP address by using the Panasonic "IP Setting Software" within 20 minutes after the restart. Reboot the camera while holding down the INITIAL SET button on the camera. The camera will be initialized and the IP address will return to the default setting "192.168.0.10". After the camera is initialized, access the camera and set the IP address again. (When the camera is initialized, all the settings of the camera previously configured on the setup menus will be initialized.) 	- Installation Guide
	<ul style="list-style-type: none"> Is "554" selected for the HTTP port number? For the HTTP port number, select a port number other than the following port numbers used by the camera. The number used by the camera: 20, 21, 23, 25, 42, 53, 67, 68, 69, 110, 123, 161, 162, 443, 554, 995, 10669, 10670, 59000 - 61000 	107

Symptom	Cause/solution	Reference pages
Cannot access from the web browser.	<ul style="list-style-type: none"> Is the same IP address provided to other devices? Are there contradictions between the address and the network subnet to be accessed? When the camera and the PC are connected in the same subnet: Are the IP addresses of the camera and the PC set in a common subnet? Or is “Use Proxy Server” for the settings of the web browser checked? When accessing the camera in the same subnet, it is recommended to enter the address of the camera in the “Don’t Use Proxy For These Addresses” box. When the camera and the PC are connected in the different subnet: Is the IP address of the default gateway set for the camera correct? 	-
	<ul style="list-style-type: none"> Is the name currently used to access the camera different from the name registered for the “Viewnetcam.com” service? Access the camera again with the registered name. 	131
	<ul style="list-style-type: none"> Did you access “http://” while using the HTTPS function? To use the HTTPS function, access “https://”. It is also necessary to enter the port number. 	119
Cannot access the camera via the Internet.	<ul style="list-style-type: none"> Are the network settings of the camera correct? Set the default gateway or DNS server address correctly. To use the DDNS service, check that the settings are correct. Is the setting for “Default gateway” on the “Network” page configured? Or is the setting correct? When communicating using IPv4: Configure the setting for “Default gateway” of “IPv4 network” on the [Network] tab of the setup menu. 	104
	<ul style="list-style-type: none"> Is the setting of port forwarding configured for the router? To enable the access to the camera via the Internet, it is necessary to perform the port forwarding setting when the router in use does not support the UPnP function. Refer to the manuals provided with the router for further information. Is UPnP function of the router disabled? Refer to the manuals provided with the router in use to enable the UPnP function. Is packet filtering set for the router to forbid the access via the Internet? Configure the settings of the router in use to enable the access via the Internet. Refer to the manuals provided with the router for further information about the settings. 	108

Symptom	Cause/solution	Reference pages
	<ul style="list-style-type: none"> Are you accessing the camera using the local address (the IP address used in a local network)? When accessing the camera, use the global address (or the URL registered in the DDNS service) and the port number of the camera as the IP address to be used in the Internet. 	<p>105 106 129</p>
<p>Cannot access the camera via the URL of the "Viewnetcam.com" service.</p>	<ul style="list-style-type: none"> Is the global address of camera (or router) notified to the "Viewnetcam.com" service server? Log into the "My Account" page of "Viewnetcam.com" website (http://www.viewnetcam.com/) to check the information of the registered camera. If the global address is not displayed for the IP address field, access the camera, and register the user information for the "Viewnetcam.com" service on the [DDNS] tab on the "Network" page of the setup menu. In addition, check the "Status" of "Viewnetcam.com" (on the [Status] tab) and the system log (on the [System log] tab) of the "Maintenance" page of the setup menu. 	<p>132 156</p>
<p>Authentication window is displayed repeatedly.</p>	<ul style="list-style-type: none"> Is the user name and password changed? While accessing the camera, when changing the user name and password of another user logging into the camera on another web browser, the authentication window will be displayed each time the screen is changed or refreshed. Have you changed the [Authentication] setting? When the [Authentication] setting has been changed, close the web browser, and then access the camera again. 	<p>-</p>
<p>It takes time to display the screen.</p>	<ul style="list-style-type: none"> Are you accessing the camera in the HTTPS mode? In this mode, the refresh interval becomes slower due to decode procession. 	<p>-</p>
	<ul style="list-style-type: none"> Are you accessing another camera in the same local network via a proxy server? Configure the web browser to not use the proxy server. 	<p>-</p>
	<ul style="list-style-type: none"> Are two or more users browsing the camera images simultaneously? It may take time to display the screen or refresh interval may become slower when two or more users browse the camera images simultaneously. 	<p>-</p>
<p>Cannot access the camera from a cellular phone.</p>	<ul style="list-style-type: none"> Is the URL correct? Or is "/mobile" missing at the end of the URL? Check if the URL is entered correctly. When accessing the camera from a cellular phone, it is necessary to enter "/mobile" at the end of the URL that is used for the camera access from a PC. 	<p>19</p>

Symptom	Cause/solution	Reference pages
	<ul style="list-style-type: none"> Is the SSL encryption method different from that of the camera? Select "HTTP" (Do not select "HTTPS") for "HTTPS" - "Connection" on the "Network" page - the [Network] tab, and access the camera again. 	104
	<ul style="list-style-type: none"> Did you access "http://" while using the HTTPS function? To use the HTTPS function, access "https://". It is also necessary to enter the port number. 	119
Cannot access the camera from a mobile terminal.	<ul style="list-style-type: none"> Is the URL correct? Or is "/cam" missing at the end of the URL? Check if the URL is entered correctly. When accessing the camera from a mobile terminal, it is necessary to enter "/cam" at the end of the URL that is used for the camera access from a PC. 	22
	<ul style="list-style-type: none"> Is the SSL encryption method different from that of the camera? Select "HTTP" (Do not select "HTTPS") for "HTTPS" - "Connection" on the "Network" page - the [Network] tab, and access the camera again. 	104
	<ul style="list-style-type: none"> Did you access "http://" while using the HTTPS function? To use the HTTPS function, access "https://". It is also necessary to enter the port number. 	119
A cookie error was displayed when performing user registration for "Viewnetcam.com".	<ul style="list-style-type: none"> Is the web browser configured to allow cookies? Configure the web browser to allow cookies. In Internet Explorer, from [Tools] select [Internet Options] and configure the cookies setting in the [Privacy] tab. 	-
User registration for the "Viewnetcam.com" service fails.	<ul style="list-style-type: none"> Is the registered E-mail address correct? When an E-mail with the "Viewnetcam.com" website link is not received, the registered E-mail address may be incorrect. Visit the "Viewnetcam.com" website (http://www.viewnetcam.com/) to register the correct E-mail address. 	-
No image is displayed.	<ul style="list-style-type: none"> Is the viewer software installed on the PC? Install the viewer software on a PC. 	3
	<ul style="list-style-type: none"> Is the version of DirectX® 9.0c or later? Check the version of DirectX as follows. <ol style="list-style-type: none"> Select "Run..." from the start menu of Windows. Enter "dxdiag" in the displayed dialog box and click the [OK] button. If the version of DirectX is older than 9.0c, upgrade it. 	-

Symptom	Cause/solution	Reference pages
	<ul style="list-style-type: none"> Is the cellular phone in use support the 320×240 resolution? Or is the image data size too big to display images on the cellular phone? Refer to the manuals provided with the cellular phone in use for the restrictions of image data sizes. 	-
No image is displayed. / Older images or logs are displayed.	<ul style="list-style-type: none"> When [Every time I visit the webpage] is not selected for [Check for newer versions of stored pages:] in the [Temporary Internet Files] section, images sometimes may not be displayed on the “Live” page. In this case, do the following. <ol style="list-style-type: none"> Select [Internet Options...] from [Tools] on the menu bar of Internet Explorer. The [Internet Options] window will be displayed. When using Internet Explorer 7.0, Internet Explorer 8.0, or Internet Explorer 9.0: Click the [Settings] button in the [Browsing history] section on the [General] tab, and then select [Every time I visit the webpage] for [Check for newer versions of stored pages:] in the [Temporary Internet Files] section on the [Temporary Internet Files and History Settings] window. When using Internet Explorer 6.0: Click the [Settings...] button in the [Temporary Internet Files] section on the [General] tab, and then select [Every visit to the page] for [Check for newer versions of stored pages:] on the [Settings] window. 	-
Images are displayed blurry.	<ul style="list-style-type: none"> Is there dust or dirt on the dome section? Check if there is no dust or dirt on the dome section. 	Installation Guide
The image is not being refreshed.	<ul style="list-style-type: none"> Depending on the version of your browser, there might be difficulties refreshing the picture, etc. 	Installation Guide
	<ul style="list-style-type: none"> Depending on the traffic of the network or the concentration of access to the camera, there might be difficulties displaying the camera picture. Request the camera picture using the web browser such as by pressing the [F5] key, etc. 	-
No image is displayed (or too dark).	<ul style="list-style-type: none"> Is the brightness setting set at an appropriate level? Click the [Normal] button of [Brightness]. 	VT164W VT164 : 10 VP104W VP104 : VP101 : 15
Images are displayed washed out.	<ul style="list-style-type: none"> Is the brightness setting set at an appropriate level? Click the [Normal] button of [Brightness]. 	VT164W VT164 : 10 VP104W VP104 : VP101 : 15
Flicker appears on the screen.	<ul style="list-style-type: none"> When flicker occurs frequently, select “Indoor scene” for “Light control mode”. 	60

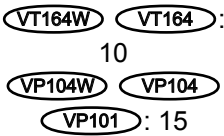
Symptom	Cause/solution	Reference pages
The camera does not move onto the preset position exactly.	<ul style="list-style-type: none"> Is any part of the camera worn out? When the camera does not move to the exact position frequently, the driving parts may be worn out. Contact the dealer for assistance. 	-
The camera does not automatically move to the previous position when turning on the power of the camera.	<ul style="list-style-type: none"> If the camera always moves to a specific position after turning on the power of the camera, register that position as the home position when convenient. The camera will automatically move to the registered position using the self return function when turning on the power of the camera. 	55
The movement of the camera automatically changes.	<ul style="list-style-type: none"> Check the settings for the self return function. 	55
Audio is not output from other products such as a network disk recorder or PC software package.	<ul style="list-style-type: none"> Some of the products such as a network disk recorder or PC software package may not support "G.711". Set the audio encoding format of the products to "G.726 (32 kbps)." 	72
The alarm occurrence indication button and the [AUX] buttons on the "Live" page do not display the current status in real time.	<ul style="list-style-type: none"> Is the viewer software installed on the PC? Confirm that the viewer software "Network Camera View 4S" is installed. 	3
	<ul style="list-style-type: none"> Is "Real time" selected for "Alarm status update mode"? 	39
No image is displayed on the "Live" page.	<ul style="list-style-type: none"> Press the [F5] key on the keyboard of the PC or click the [Live] button. 	 VT164W VT164 : 10 VP104W VP104 : 15 VP101 : 15
Shortcut icon of the camera is not displayed on "My Network Places" of the PC.	<ul style="list-style-type: none"> Is the Windows component of UPnP added? Add the component to the PC in use. 	108
Images are not displayed or not refreshed smoothly.	<ul style="list-style-type: none"> Delete temporary internet files as follows. <ol style="list-style-type: none"> Select "Internet Options..." under "Tools" on the menu bar of Internet Explorer. The "Internet Options" window will be displayed. Click the [Delete Files...] button in the "Temporary Internet Files" section on the [General] tab. 	-
	<ul style="list-style-type: none"> The firewall function of the anti-virus software may be filtering the port of the camera. Exclude the port number of the camera from the list of the port numbers to be filtered by the anti-virus software. 	-
No indicator lights.	<ul style="list-style-type: none"> Is "Off" selected for "Indicator" on the "Basic" page? Select "On" for "Indicator". 	39

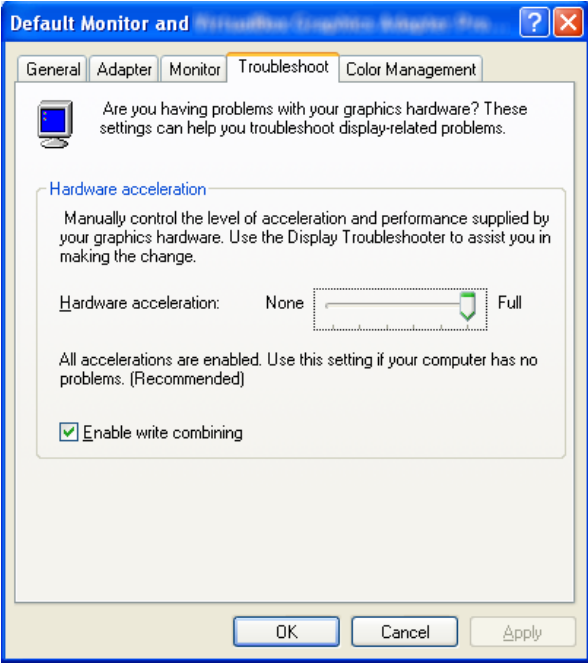
Symptom	Cause/solution	Reference pages
<p>H.264 images are not displayed.</p>	<ul style="list-style-type: none"> When “Network Camera View 4S” is deleted from a PC on which both the viewer software “Network Camera View 3” and “Network Camera View 4” are installed, H.264 images may not be displayed. In this case, delete “Network Camera View 3” from the PC and then install “Network Camera View 4S”. 	<p>3</p>
<p>When displaying H.264 images on two or more web browser windows, images from two or more cameras are displayed in sequence on a single browser window.</p>	<ul style="list-style-type: none"> This may occur due to the display adapter and driver combination. When this has occurred, first update the driver of the display adapter to the latest version. If updating the driver does not solve the problem, adjust the hardware acceleration as follows. The following are descriptions for when Windows XP is installed on the PC in use. <ol style="list-style-type: none"> Right-click on the desktop and select “Properties” from the displayed pop-up menu. Select “Settings” from “Display Properties”, and then click the [Advanced] button. Click the [Troubleshoot] tab and disable the DirectDraw acceleration by adjusting the level of Hardware acceleration. 	<p>-</p>

Symptom	Cause/solution	Reference pages
Cannot connect to the wireless router VT164W VP104W	<ul style="list-style-type: none"> Is the camera in an area with no wireless signal, or is there a concrete wall or other obstructions between the camera and wireless router? Check the [Radio wave status] from [Wireless] - [Status] on the setup menu, and install the camera in an area that is close to the wireless router, has no interfering objects, and can easily receive signals. 	148
	<ul style="list-style-type: none"> Did you register the camera's MAC address to wireless routers that have MAC address filtering activated? Register the camera's MAC address to the wireless router. You can check the camera's MAC address from the sticker attached to the camera or from the MAC address displayed in [Mac address of the wireless module] from [Wireless] - [Status] on the setup menu. 	-
Wireless communication is unstable VT164W VP104W	<ul style="list-style-type: none"> Is the channel used for wireless communication the same as another nearby wireless networks? Try changing the wireless communication channel of the wireless router. For information about changing the communications channel, refer to the operating instructions included with your wireless router. 	-
	<ul style="list-style-type: none"> Is a cordless telephone or other devices or objects causing interference? Try moving the cordless telephone or other devices or objects causing interference. Refer to [Radio wave status] from [Wireless] - [Status] on the setup menu, and try moving the camera closer to the wireless router or removing objects causing interference to make it easier for the wireless signal to reach the camera. 	148

Information Bar

Depending on the OS installed on the PC, the following may occur. Follow the instructions below when the following has occurred. By performing the following solutions, other applications may not be affected.

When using Internet Explorer 9.0:

The “Information Bar” (①) expressed in the following symptom and solutions will be displayed on the lower side of the Internet Explorer page only when there is information to communicate.

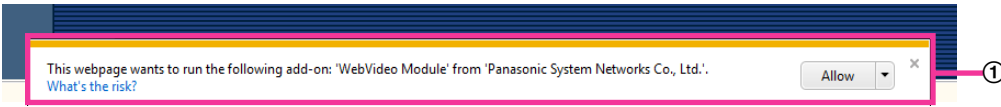

When using Internet Explorer 6.0, Internet Explorer 7.0, or Internet Explorer 8.0:

The “Information Bar” (②) expressed in the following symptom and solutions will be displayed just below the address bar only when there is information to communicate.

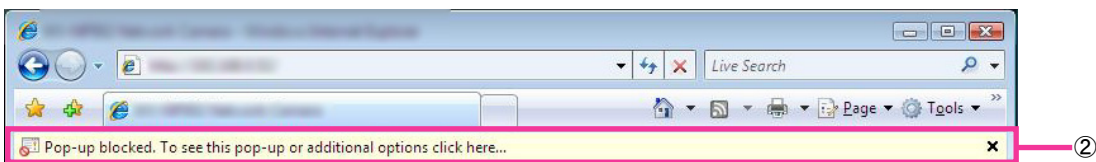

Symptom	Cause/solution	Reference pages
The following message is displayed on the information bar. “Pop-up blocked. To see this pop-up or additional options, click here...” (Internet Explorer 6, Internet Explorer 7, or Internet Explorer 8)	<ul style="list-style-type: none"> Click the information bar and select “Always Allow Pop-ups from This Site...”. The dialog window saying “Allow pop-ups from this site?” will be displayed. Click the [Yes] button. 	-
The following message is displayed on the information bar. “This webpage wants to run the following add-on: `WebVideo Module' from `Panasonic System Networks Co.,Ltd.`.” (Internet Explorer 9)	<ul style="list-style-type: none"> Select [Allow]. 	-
The following message is displayed on the information bar. “This site might require the following ActiveX control 'nwcV4Ssetup.exe' from 'Panasonic System Networks Co.,Ltd.'. Click here to install...” (Internet Explorer 6, Internet Explorer 7, or Internet Explorer 8)	<ul style="list-style-type: none"> Click the information bar and select “Install ActiveX Control”. The “Security Warning” window will be displayed. Click the [Install] button on the displayed “Security Warning” window. 	-

Symptom	Cause/solution	Reference pages
<p>The following message is displayed on the information bar. “This webpage wants to install the following add-on: `nwc4Ssetup.exe` from `Panasonic System Networks Co.,Ltd.`.” (Internet Explorer 9)</p>	<ul style="list-style-type: none"> Select [Install]. The “Security Warning” window will be displayed. Click the [Install] button on the displayed “Security Warning” window. 	-
<p>An unnecessary status bar or scroll bar is displayed on the pop-up window.</p>	<ul style="list-style-type: none"> Click “Internet Options...” under “Tools” of the menu bar of Internet Explorer, and then click the [Security] tab. Click “Internet” in the “Select a Web content zone to specify its security settings.” section. Then, click the [Custom Level...] button to open the “Security Setting” window. Under “Miscellaneous”, select “Enable” for “Allow script-initiated windows without size or position constraints”. Click the [OK] button. When the warning window is displayed, click the [Yes] button. 	-
<p>Images are not fit in the frames.</p>	<ul style="list-style-type: none"> When “120 DPI” is selected for “DPI setting”, they may not be displayed correctly. Click the “Settings” tab on the “Properties” window of “Screen” (in the control panel), and then click the [Advanced] button. Change the “DPI setting” as necessary. 	-

For U.S. and Canada:

**Panasonic System Communications Company of North America,
Unit of Panasonic Corporation of North America**

www.panasonic.com/business/

For customer support, call 1.800.528.6747

Three Panasonic Way, Secaucus, New Jersey 07094 U.S.A.

Panasonic Canada Inc.

5770 Ambler Drive, Mississauga, Ontario, L4W 2T3 Canada

(905)624-5010

www.panasonic.ca

For Europe and other countries:

Panasonic Corporation

<http://panasonic.net>

Importer's name and address to follow EU rules:

Panasonic Testing Centre

Panasonic Marketing Europe GmbH

Winsbergring 15, 22525 Hamburg F.R.Germany